

Based on ten-dimensional space-time of String theory exploring Dark Matter of the Earth

NEWIDEA RESEARCH CENTER

HSIEN-JUNG HO

<http://newidea.org.tw>

E-mail: newidea.ufoho@msa.hinet.net

Abstract

The dark matter puzzles scientists for more than 80 years, until now still no solution. Apply the String theory, which has the characteristics of ten-dimensional space-time, to solve the problem. According to “Causality Principle” and “Anthropic Principle”, the full Universe may be divided into triple Universes, and the dark matter should be taken as a terrestrial planet in other space than ours. The best method of exploring dark matter is to start from the Earth where we live. According to the characteristics of the Earth's interior, equitably examining its constitution, temperature, density and pressure from a different view of the core, the special arguments are put forward. It is inferred that the solid rock and the magma change states interactively at the CMB. In the low viscosity F-layer of outer core, high temperature causes some elements and oxides of magma to undergo oxidation-reduction reactions and separate due to its gravity. The great amount of heats, produced from radiogenic heat, chemical reaction heat and nuclear fission heat, become the power sources for the geo-dynamo of great convection cell, which are the flows of the magma and the solid rock migrating up to the crust and down across the CMB to the F-layer. Based on the new conception and applying a simplified method tries the different density distribution curves of 4 models in the core to calculate the data of the Earth, and compared with the existing current data of the Earth. The insufficient mass and moment of inertia are the missing matters, which are taken as the parts of dark matter, which may be in the interior of the Earth. Apply the simplified method to evaluate the Earth's mass and moment of inertia that are found to be only 85.73% and 94.82% of the current data. By the two insufficiencies of the Earth's data, formulating the reasonable assumptions, a planet of dark matter inside the earth has been figured out. And then calculate gravity and pressure in every depth within the Earth to check suitability or not. Finally a dark matter, radius 3700.375 km planet about 1.33 times of Mars, is reasonably inside the Earth but other space than ours. The new Earth model may be confirmed from Chandler wobble, and some great scientific problems, such as: dark matter, dark energy and composition of the Earth, etc., have been roughly solved.

The Universe fills with dark matter

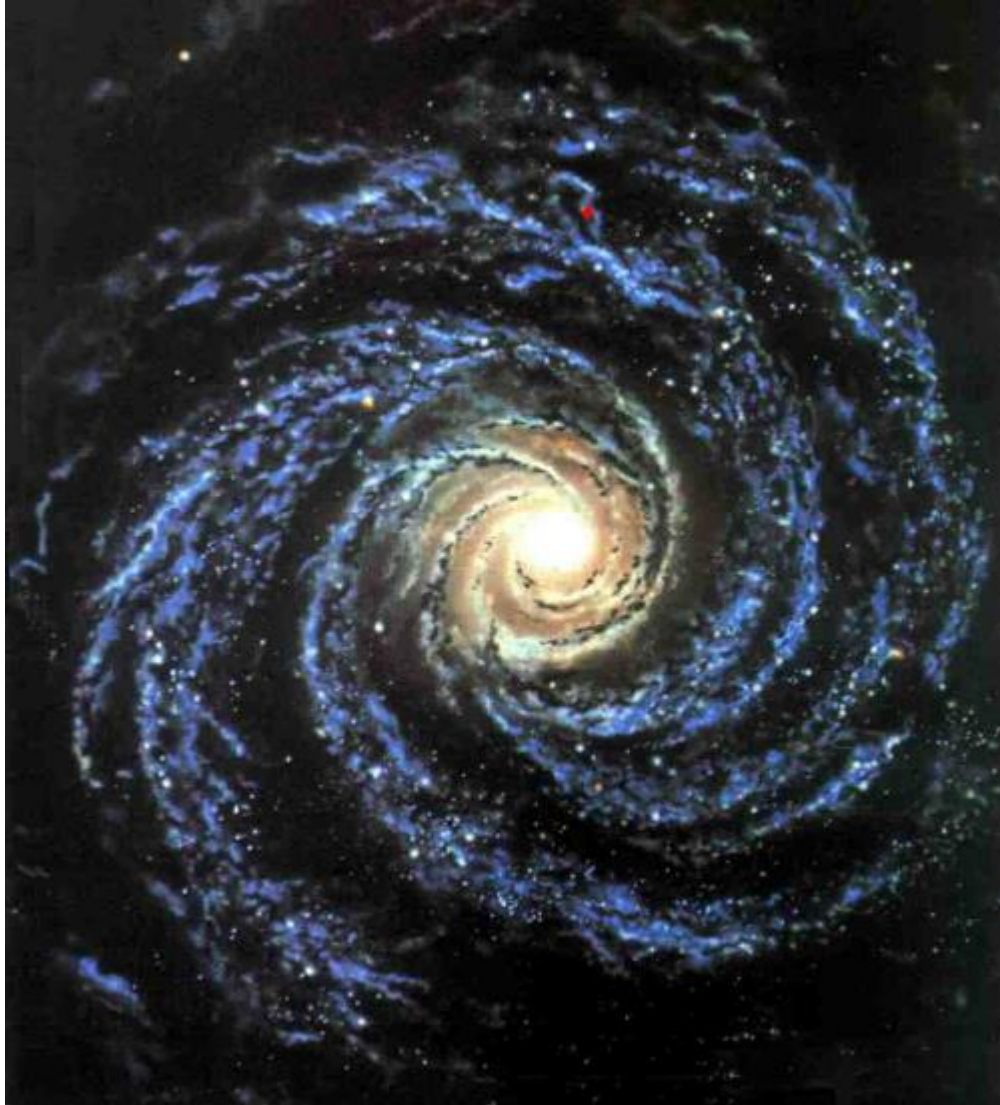

Milk Way diagram, Solar system is red point in up part.

The total mass of stars in a galaxy, which can be estimated by observing the orbiting stars of galaxy with an astronomical telescope, is less than 10% of this total mass of galaxy. In 1988, Unobservable matter, called dark matter, amounted to more than 90 % mass of the entire galaxy. The phenomenon appears throughout the Universe, so the Universe fills with dark matter.

Redshift light denotes galaxies of the Universe expansion



Astronomer Hubble

In 1929, American astronomer Hubble studied light of galaxies, found that most stars were showing signs of red shift that means numerous stars expand in the Universe. Absorption lines from the Sun (up) and from BAS11(down), the star is leaving us.

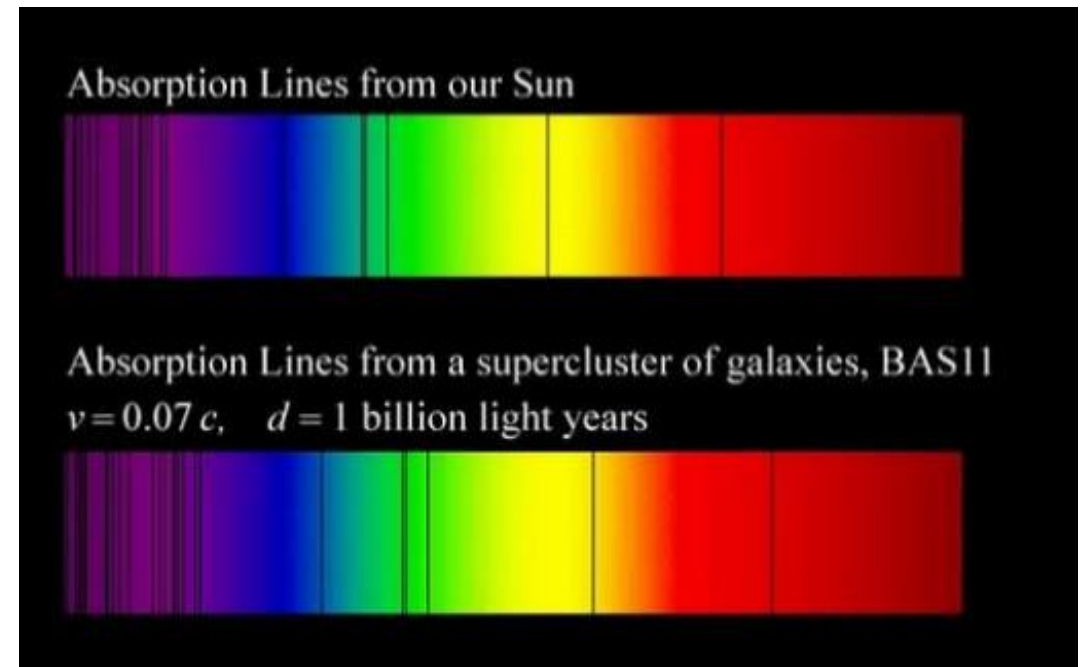

Cepheid variable star is called Cosmic Distance Ladder



Cepheid variable star is recognized as standard candles, called Cosmic Distance Ladder, which is taken to survey distance of stars. In 2001, Freeman detected luminance of 800 Cepheid variable stars, and confirmed that the Universe is expanding, and calculated “Big bang” at 13.7 billion (current 13.8 billion) years ago.

V838 Monocerotis Cepheid variable star

Evolution of V838 Monocerotis Cepheid variable star

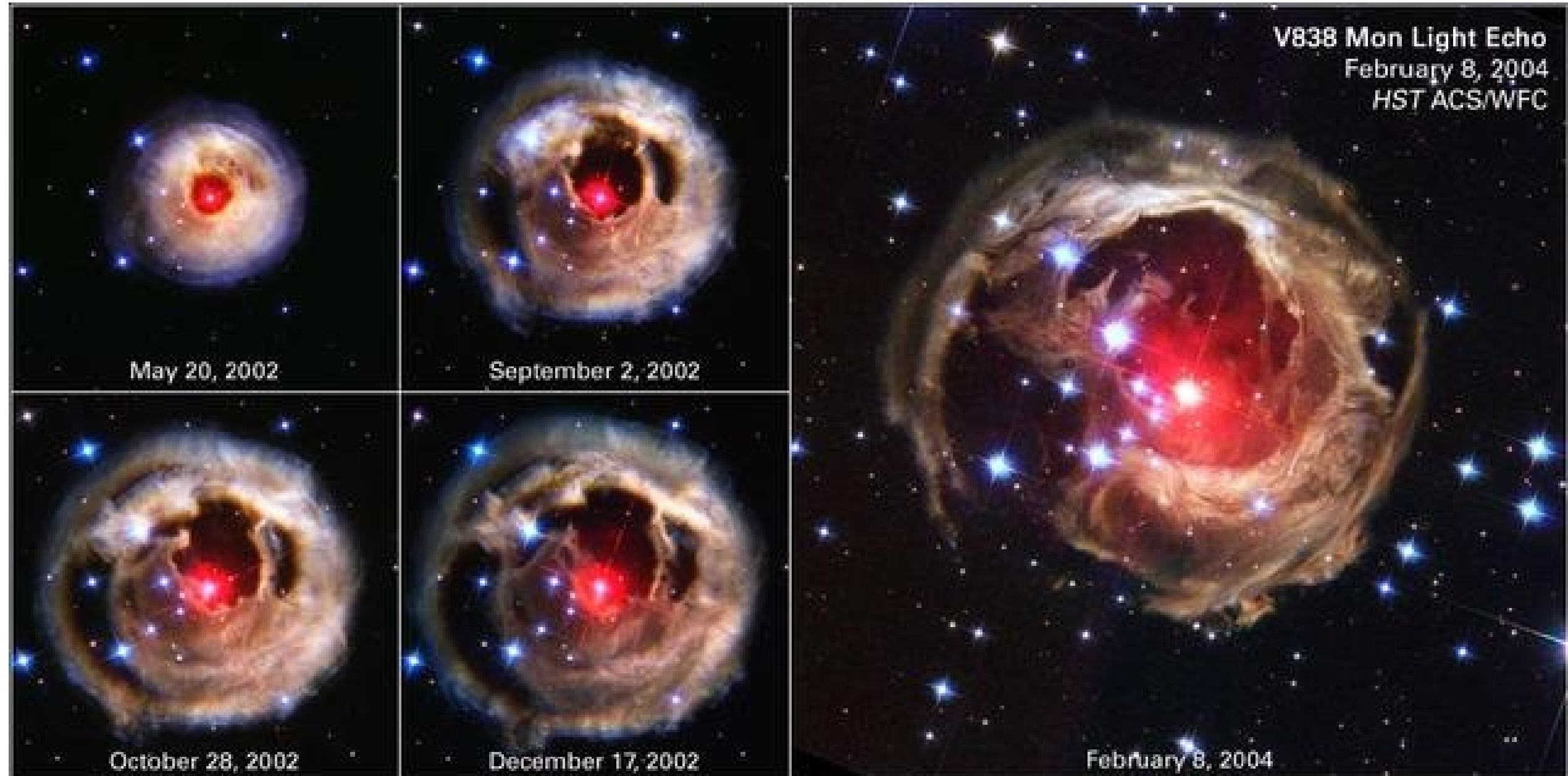

The stars of the Universe are accelerating expansion

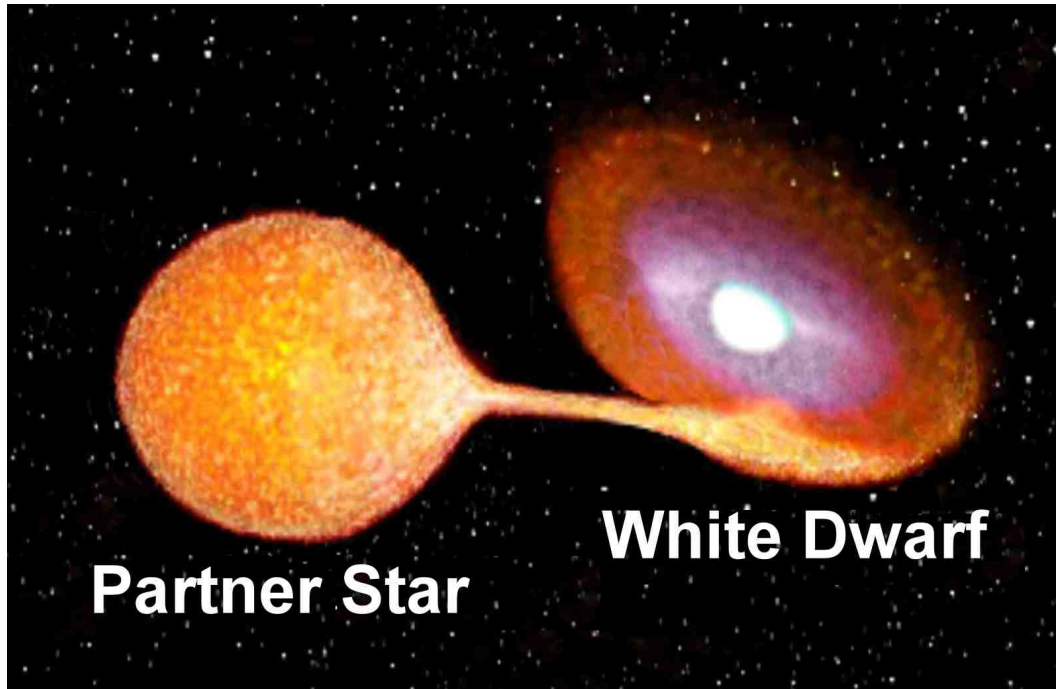

Type 1a supernovae of
double star system

1a supernovae and 34 nearby supernovae found that the expansion of the Universe has been accelerating, and the rate was increasing.

In double star system, A white Dwarf, whose mass is a little bigger than the Sun, attracts a partner star to increase its mass, when up to 1.38 times of Sun that must burst into a type 1a supernova, whose luminance just a standard candle. The standard candle can be used to determine the distances of it. In 1998, scientists from the data of 16

Acceleration of the Universe expansion is thought dark energy existing

In visible Universe, there is no indication to explain the acceleration of the Universe expansion. Cosmologists infer an assumption of some unknown kind of “dark energy” existing. Scientists believe the tearing energy of the Universe is dark energy, but dark matter condenses everything. The two forces mutual act on, but dark energy is much bigger than dark matter, therefore, forming today we know the phenomenon of the accelerating expansion of the Universe. Dark energy is a current scientific hypothesis, being neither matter nor radiation. Its physical properties have no any clue, and we don't know how it works, but doubt the possibility of the existence of it.

The Universe is full of invisible things

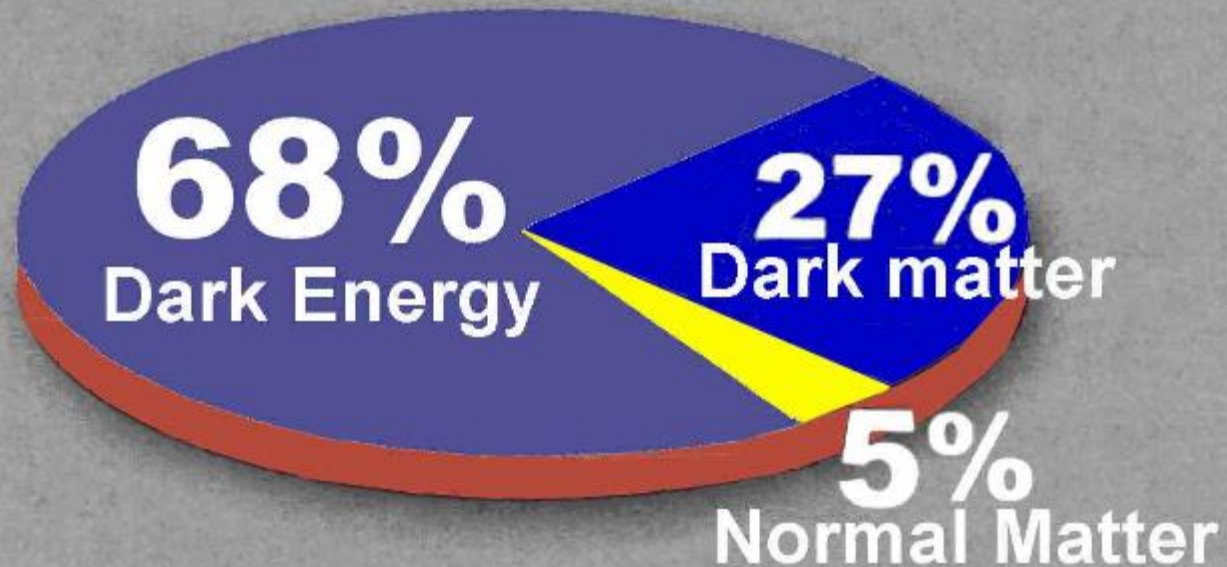
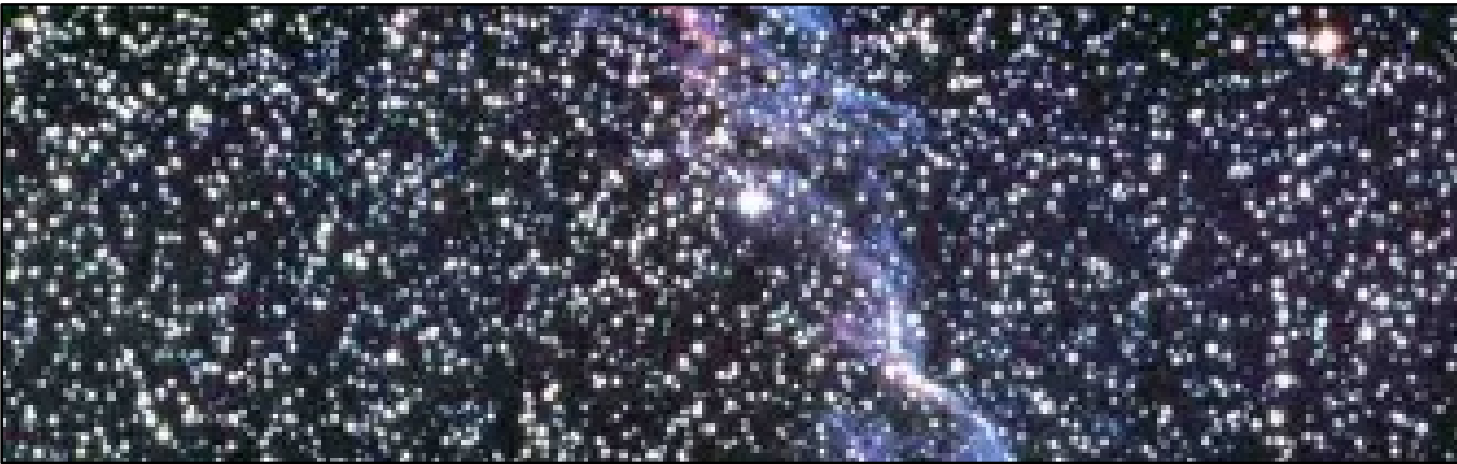

In the vastness of the Universe, now we can see visible stars and ordinary normal matters only occupies 5 % of the Universe, the rest 95 % is missing, including 27 % of dark matter and 68% of dark energy. The missing matter we do not know what is? This is the biggest problem for scientists.

String theory bases on the Universe framework of 10-dimensional space-time

In order to address some questions and many others, in 1970s String theory was introduced. String theory has been strictly proved the mathematical theory. It is currently the only one that can unify the four fundamental forces of nature, and potentially provides a unified description of gravity and particle physics. String theory bases on the Universe framework of nine-dimensional space and one-dimensional time, called framework of 10-dimensional space-time. It is the point-like particles that can be modeled as one-dimensional objects called string.

String theory is a theory of quantum gravity

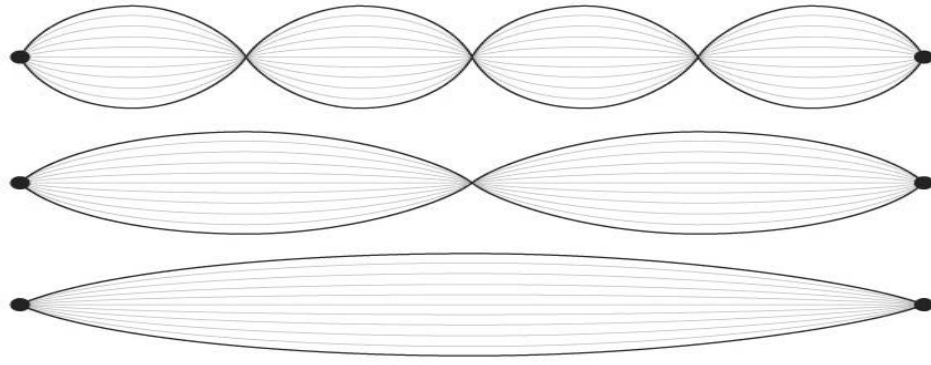

Change of closed string

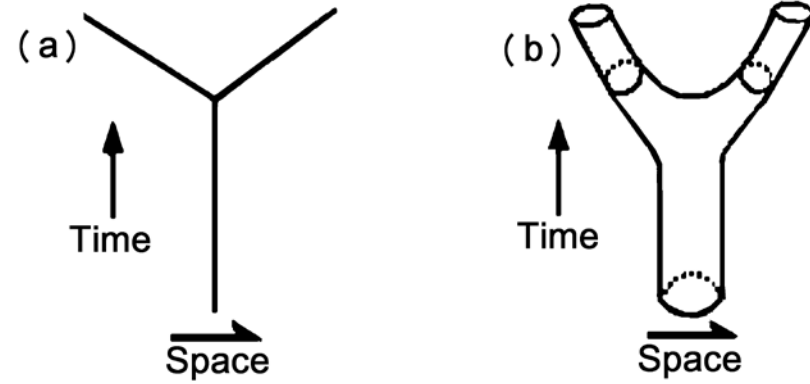

Change of open string (a) and relative time space (b)

Strings are a row movements of variety of specific vibrational modes, different modes correspond to variety of different properties of elementary particles; all elementary particles is the lowest energy state of a string, which is the ground state. Strings use interaction modes between closed string and open string, corresponding to the interaction modes between particles as four fundamental forces of nature.

9-dimensional space of the Universe is no way to compactify into 3 dimension

In order to meet the present situation of the Universe in which we live, physicists have attempted to break ten-dimensional space-time model down through spontaneous symmetry breaking, to a four-dimensional one as our known world and 6-extra-dimensional space, which is compacted to be tiny space called Calabi-Yau space as Plank space 10^{-33} cm, but no proposed method meets perfection. Because some scientists do not think the extra dimensions of space are curled up into tiny spaces, but as our three dimensional one. So the Universe should maintain the equivalent mathematical weight to nine-dimensional space.

Scientist suggested extra dimensions of space just like our ordinary three-dimensional view

In 2004, Dvali suggested that the extra dimensions of space should be not compactified, but infinite in size and uncurved, just like our ordinary three-dimensional view. They rethink the "extra dimension" problem that is, graviton can roam to an additional dimensions of space. They think that the accelerated expansion of the Universe is not caused by dark energy, but because gravity leaks out of our world. In particular, the theory predicts the Universe has extra dimensions into which gravity, unlike ordinary matter, may be able to escape. This leakage would warp the space-time continuum and cause cosmic expansion to accelerate. Thus the extra dimensions need not be small and compactify, but outside our ordinary three-dimensional space. So, there are the same six extra dimensions of space as ours in the Universe.

The Universe should be 3-cosmic framework from Causality Principle and Anthropic Principle

String theory bases on 10-dimensional space-time. According to “Causality Principle”, an effect cannot occur before its cause, which means time has a direction and cannot be divided into some different parts, so one-dimensional time is taken as a common standard in order of event in the Universe. According to “Anthropic Principle”, which is the simple fact that we live in a Universe set up to allow our existence. It means three-dimensional space and one-dimensional time are taken as one Universe as our living world. Therefore, the 10-dimensional space-time can be divided into three portions of space, and each portion has a common standard time that means there are three-cosmic framework in the Universe. Our world is one of the three-cosmic world.

The schematic diagram of nine-dimensional space in the three-cosmic framework of Universe

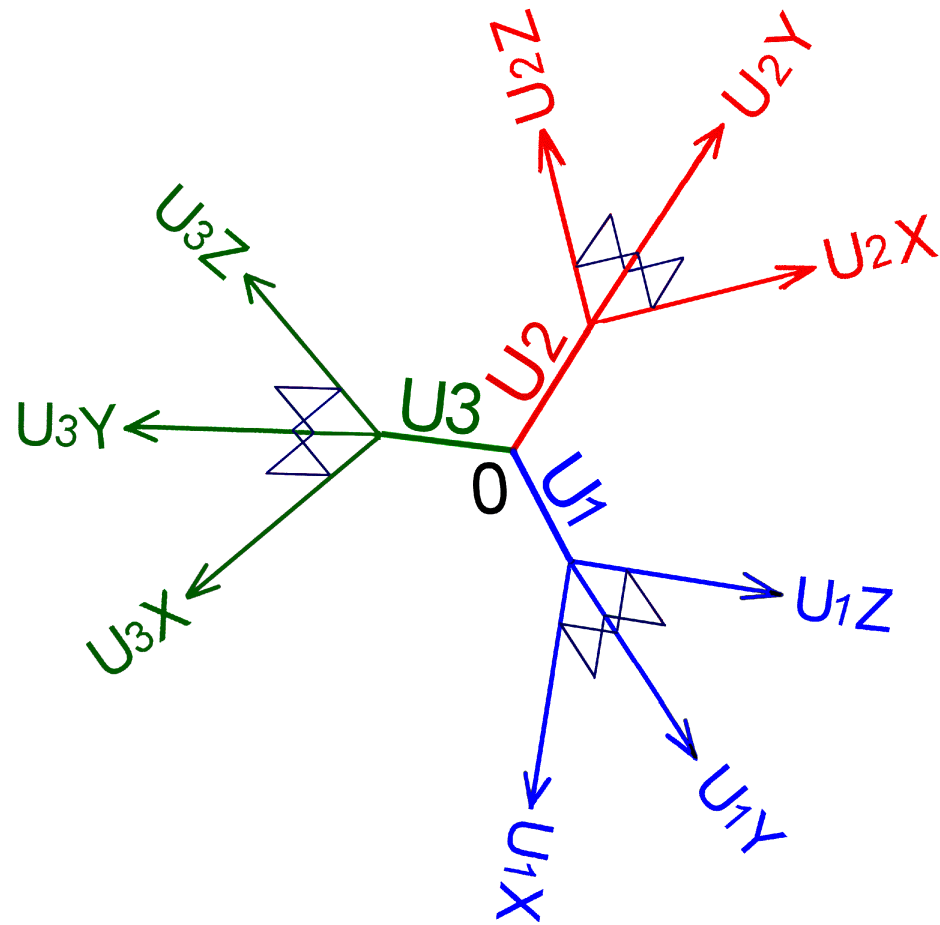

- U_1 : 1st Universe
- U_2 : 2nd Universe
- U_3 : 3rd Universe
- U_1X : X axle of 1st Universe
- U_1Y : Y axle of 1st Universe
- U_1Z : Z axle of 1st Universe
- U_2X : X axle of 2nd Universe
- U_2Y : Y axle of 2nd Universe
- U_2Z : Z axle of 2nd Universe
- U_3X : X axle of 3rd Universe
- U_3Y : Y axle of 3rd Universe
- U_3Z : Z axle of 3rd Universe

All the 3 Universe's exist, but none of forces can communicate with another except gravity.

Multiverse can contain dark matters

According to String theory, matters can exist in different world; i.e. multiverse exists. From the quantum experiment, elementary particles in the structure of atoms as electrons orbit the nucleus of an atom, not in stable orbit, but intermittently appear in many places. The only explanation is that the particles not only exists in our Universe, but also swept to another Universe, indicates multiverse exists in space. In multiverse, among any another worlds, there is no basic interactive forces of nature except gravity, i.e. the theoretic graviton in the field of gravity can penetrate all Universes; however, the light cannot. So the dark matter may be situated in the Universes other than ours, in other words. the multiverse can contain dark matters.

Scientist devised a theory of multiple Universes

In 1957, Princeton University Dr. Hugh Everett devised “the many-worlds interpretation (MWI) of quantum mechanics”. The core of the idea was to interpret in the quantum world, an elementary particle, or a collection of such particles, can exist in a superposition of two or more possible states of being. An electron, for example, can be in a superposition of different locations, velocities and orientations of its spin. Yet anytime scientists measure one of these properties with precision, they see a definite result—just one of the elements of the superposition, not a combination of them. Nor do we ever see macroscopic objects in superpositions. MWI is a theory of multiple Universes.

First evidence for gravitational pulling stars from other Universes

In 2001, NASA launched the Wilkinson Microwave Anisotropy Probe to detect the radiant heat remaining from the big bang. The map of cosmic background radiation shows a stronger concentration in the south half of the sky and a 'cold spot' that cannot be explained by current understanding of physics. In 2005, Laura of theoretical physicist at the University of North Carolina, and professor Holman of Carnegie Mellon University, predicted that anomalies in radiation existed, and can only have been caused by the gravitational pull from other Universes. Its identical to the NASA team found that both coincide, and the same with the article of this paper.

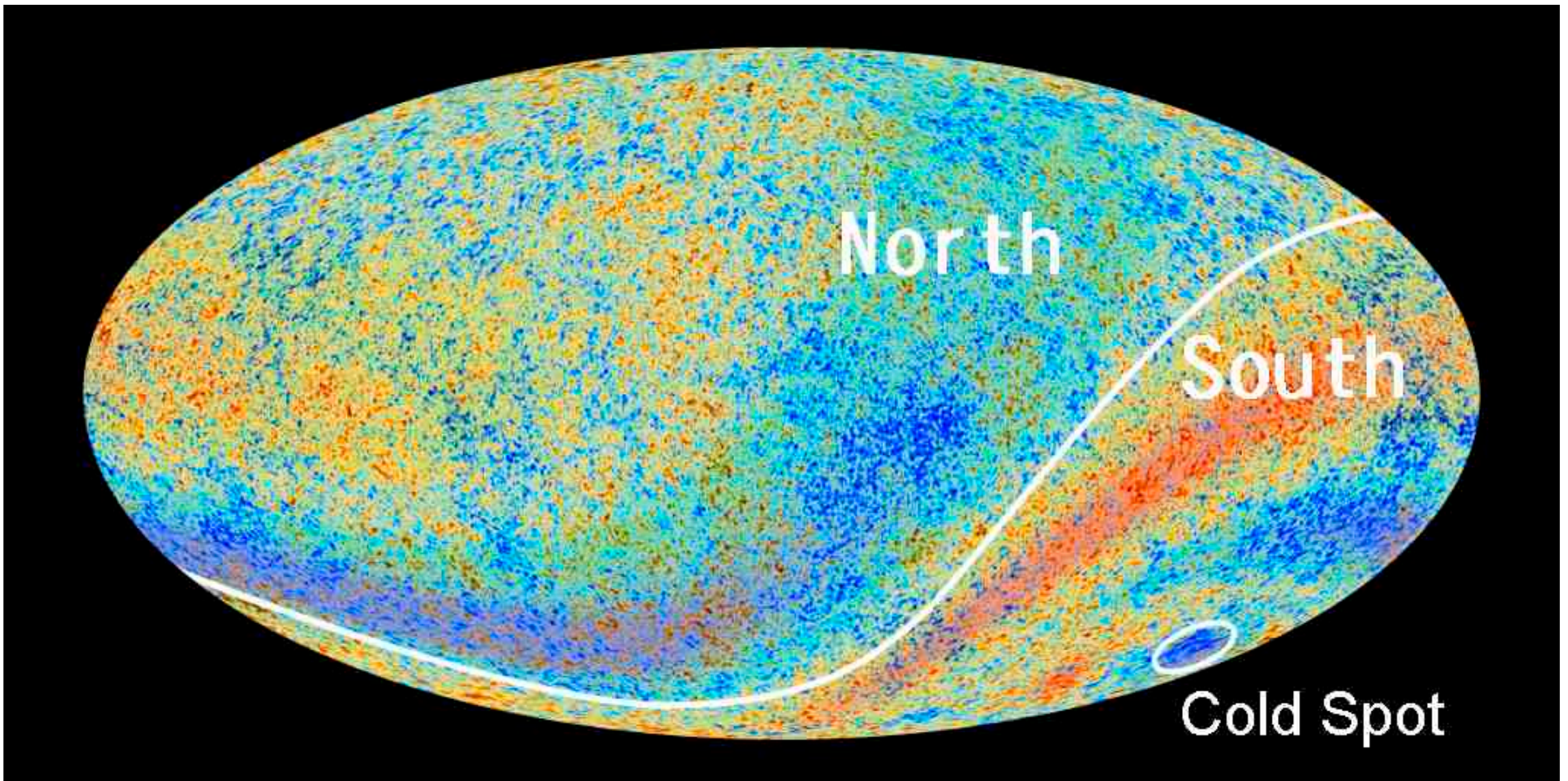

In map of cosmic background radiation has confirmed the north/south differences and a 'cold spot' in the south half of the sky that exists anomalies in radiation.

Other Universe is pulling the stars of our world accelerating expansion

Scientists assume existence of “dark energy”, which will cause the stars of the Universe accelerating expansion. But what dark energy is now the public knows nothing and no search. We can only see the whole Universe containing 5% normal matter, but 95% missing, which is star’s mass of the Universe other than ours. Because the great quantity of these stars is pulling the stars of our Universe accelerating expansion by gravity that scientists interpreted as the effect of dark energy. In fact, the only great amounts of dark matter of the Universe exists, but no dark energy. So we explore the problems should only be dark matter.

Researching dark matter from geoscience

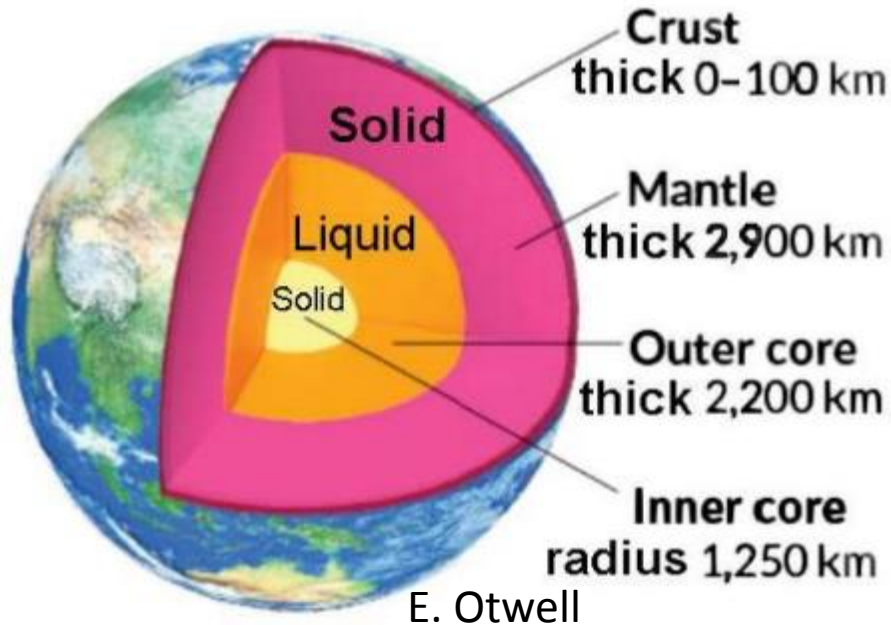

The profile chart of the Earth's structure

The best method of exploring dark matter is to start from the Earth where we live. In the current Earth model, the portions of the crust and the upper mantle have been analyzed with satisfactory accuracy. Regarding the lower mantle and the core portion, however, there remain a number of questions to be answered. The mantle and the core are not in chemical equilibrium and the fine structure of the CMB is not well understood. Thermal equilibrium in the inner/outer core remains without conclusion. There are also some discrepancies in the interior of the Earth.

Diagram of double convection cells in the Earth's structural model

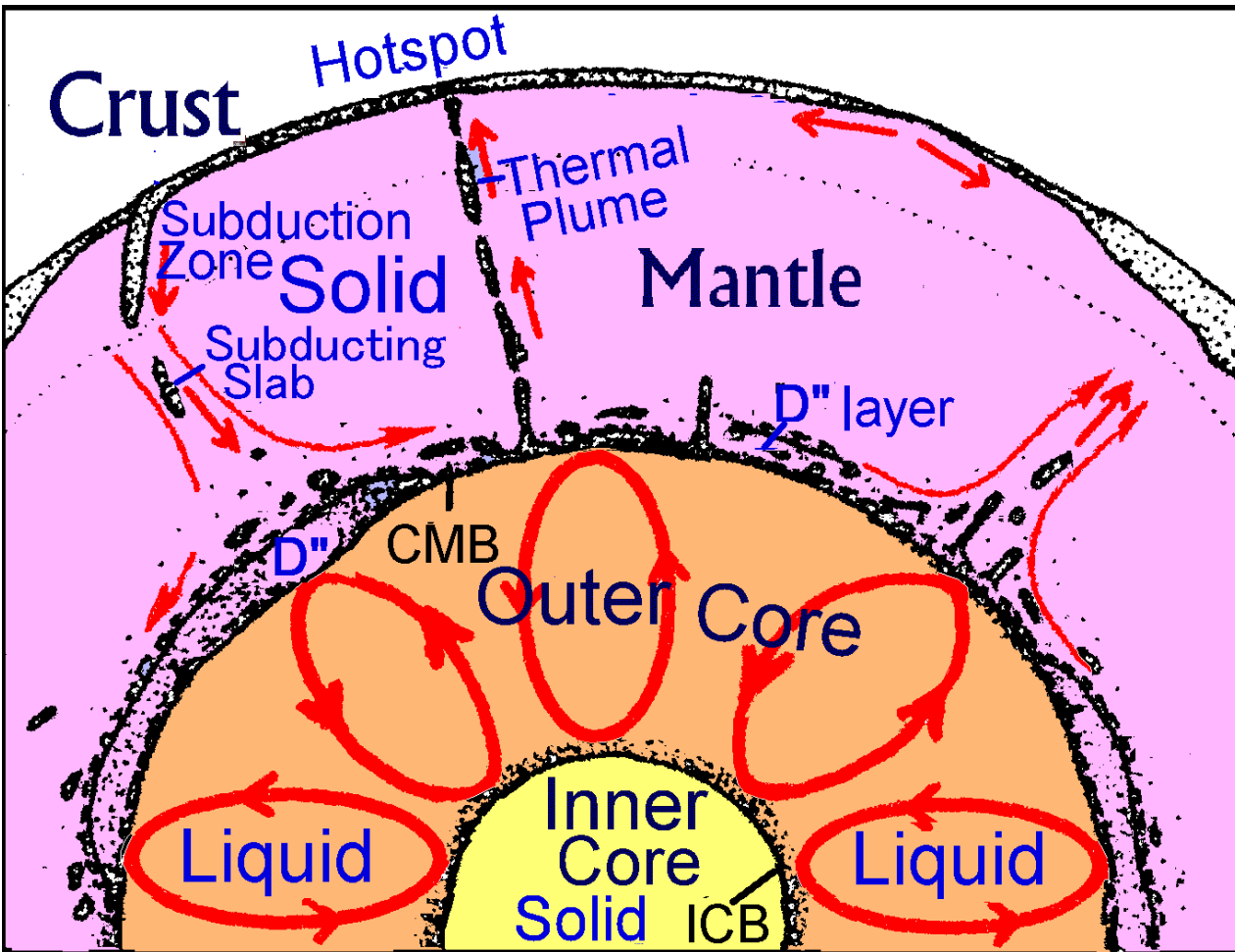

The double convection cells in the Earth's structural model

There is a convection cell spanning crust and lower mantle, and another one inside the outer core to form the double convection cells inside the Earth. The D'' layer, above the CMB, is considered to isolate the core from the rocky mantle virtually, but sustain the chemical and thermal equilibriums between the mantle and the core.

Diagram of double convection cells in the Earth's interior

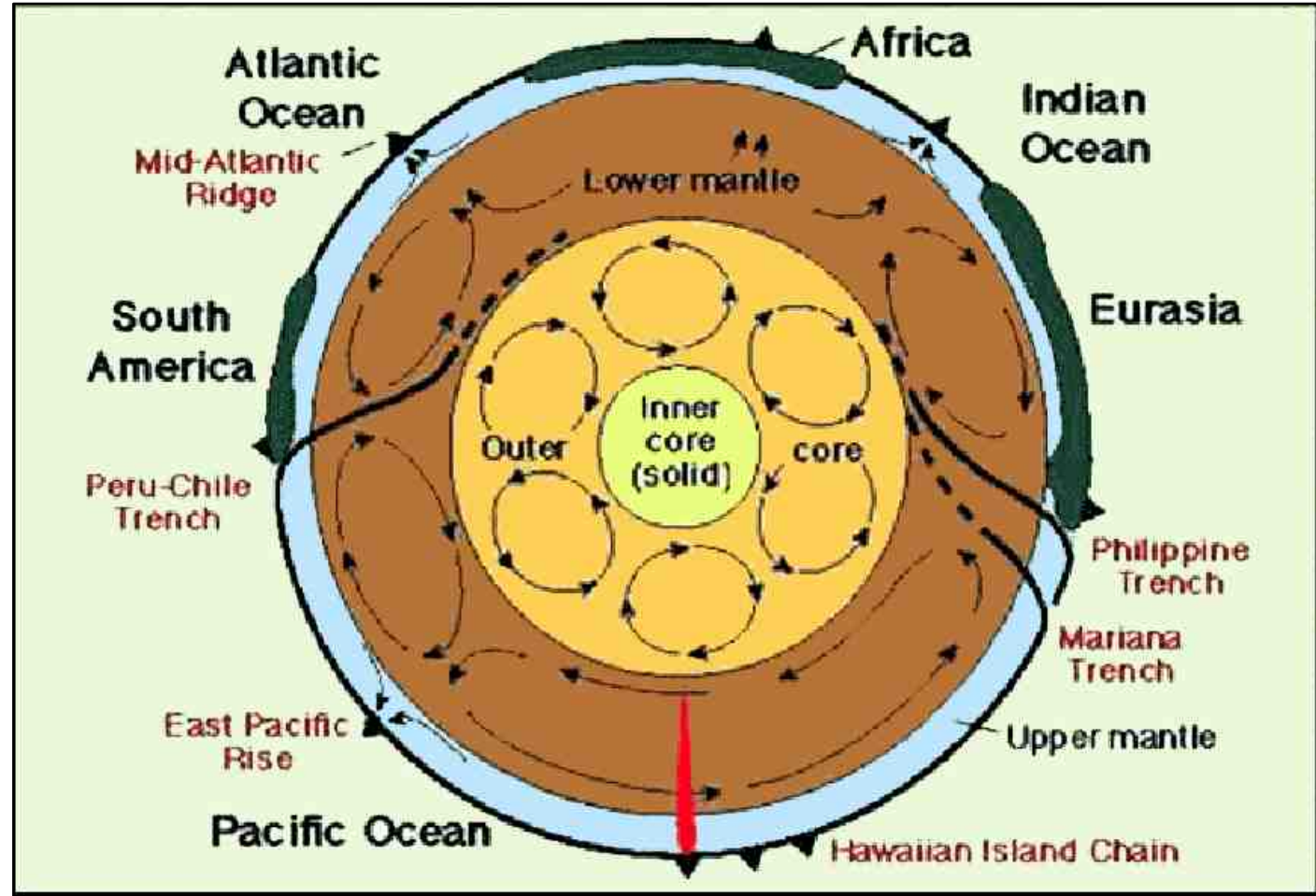
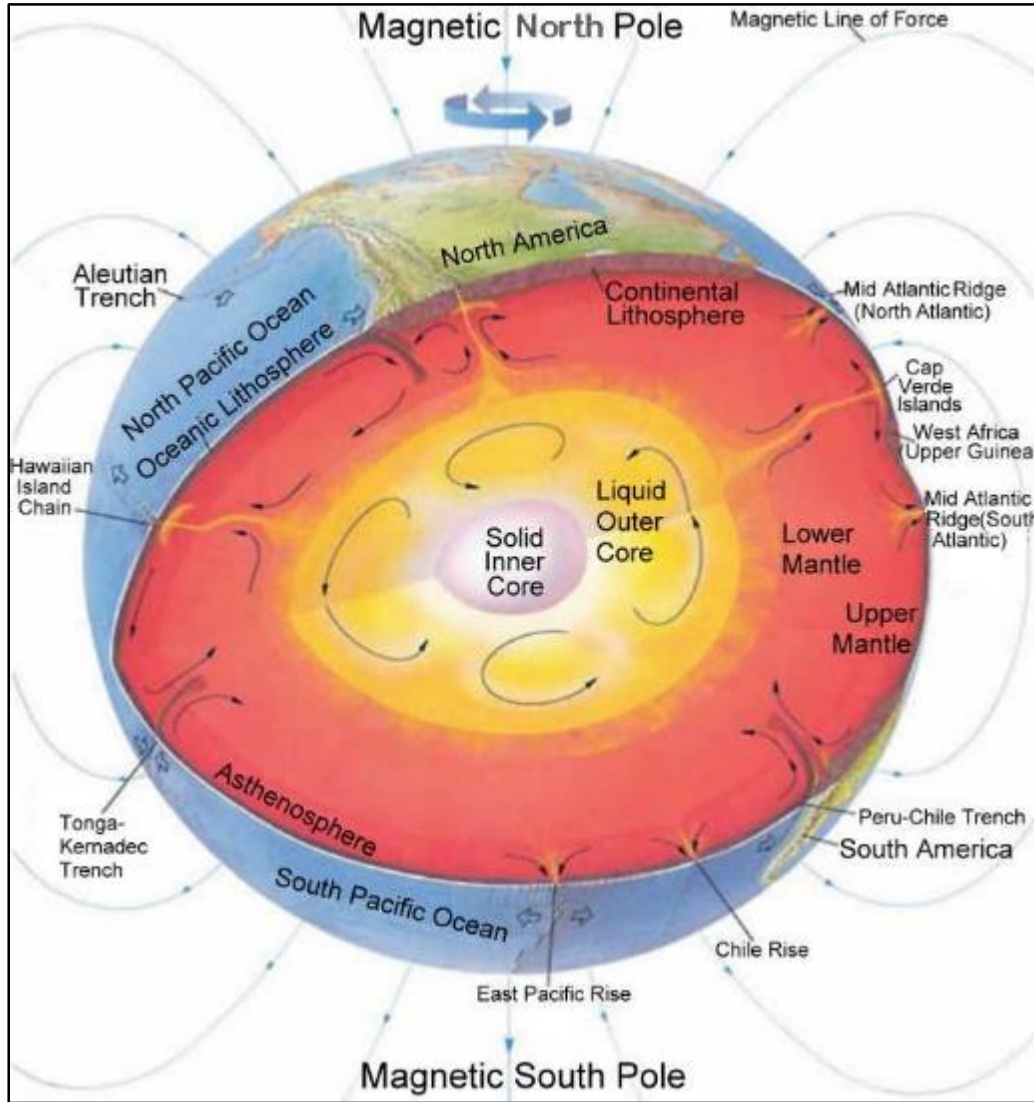

Double convection cells and magnetic field in the Earth's interior

Double convection cells in the Earth's interior

Seismic velocity and density in the Earth's interior

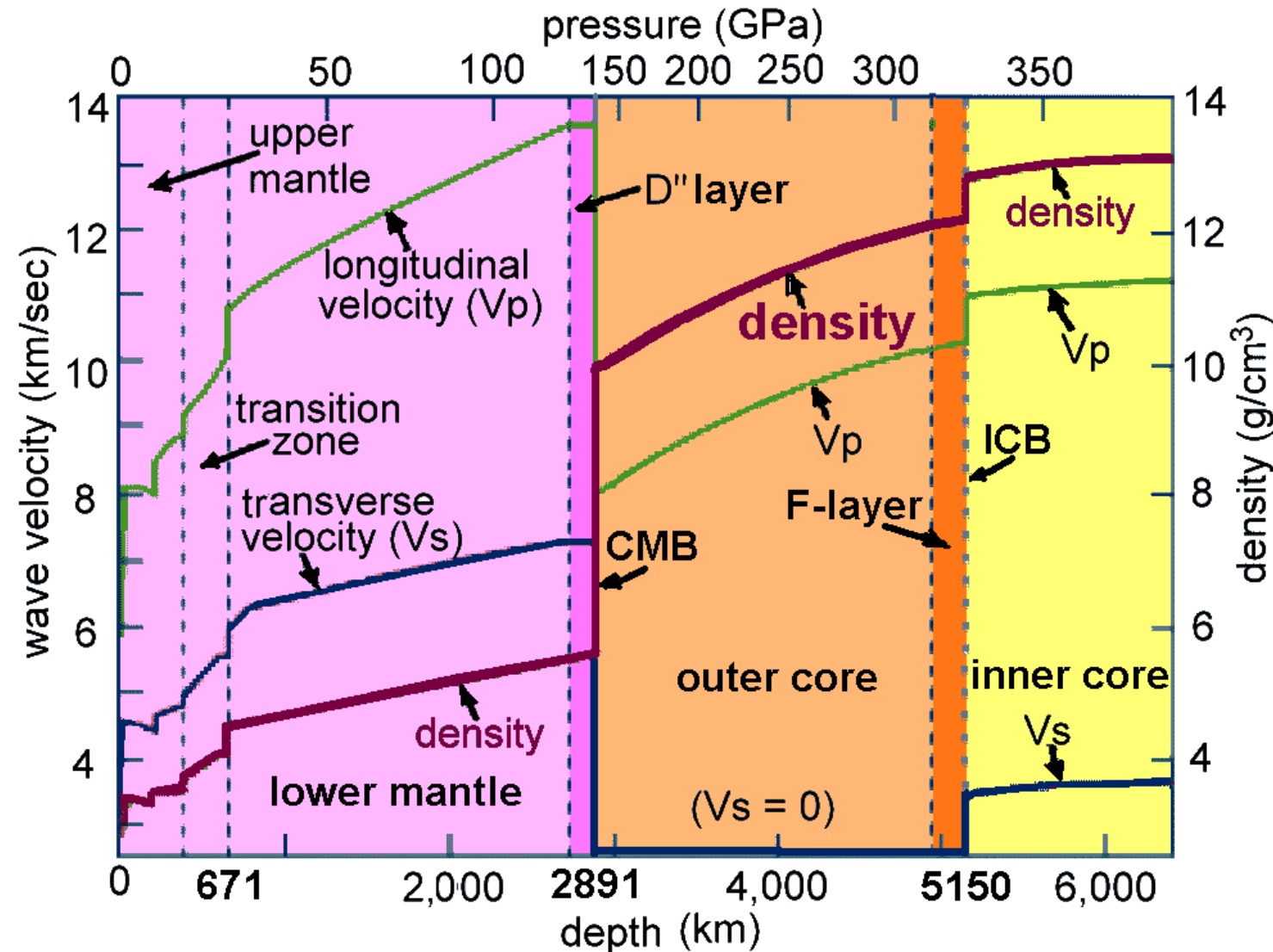

Preliminary Reference Earth Model (PREM)

Deducting the certain quantities of the crust and the mantle portion from the known data of the mass and the moment of inertia of the Earth, there are the great amounts of rest values. In order to match it, the ordinary way is to set a distribution of high density in the core and also a high density jump 77.74 % at the CMB.

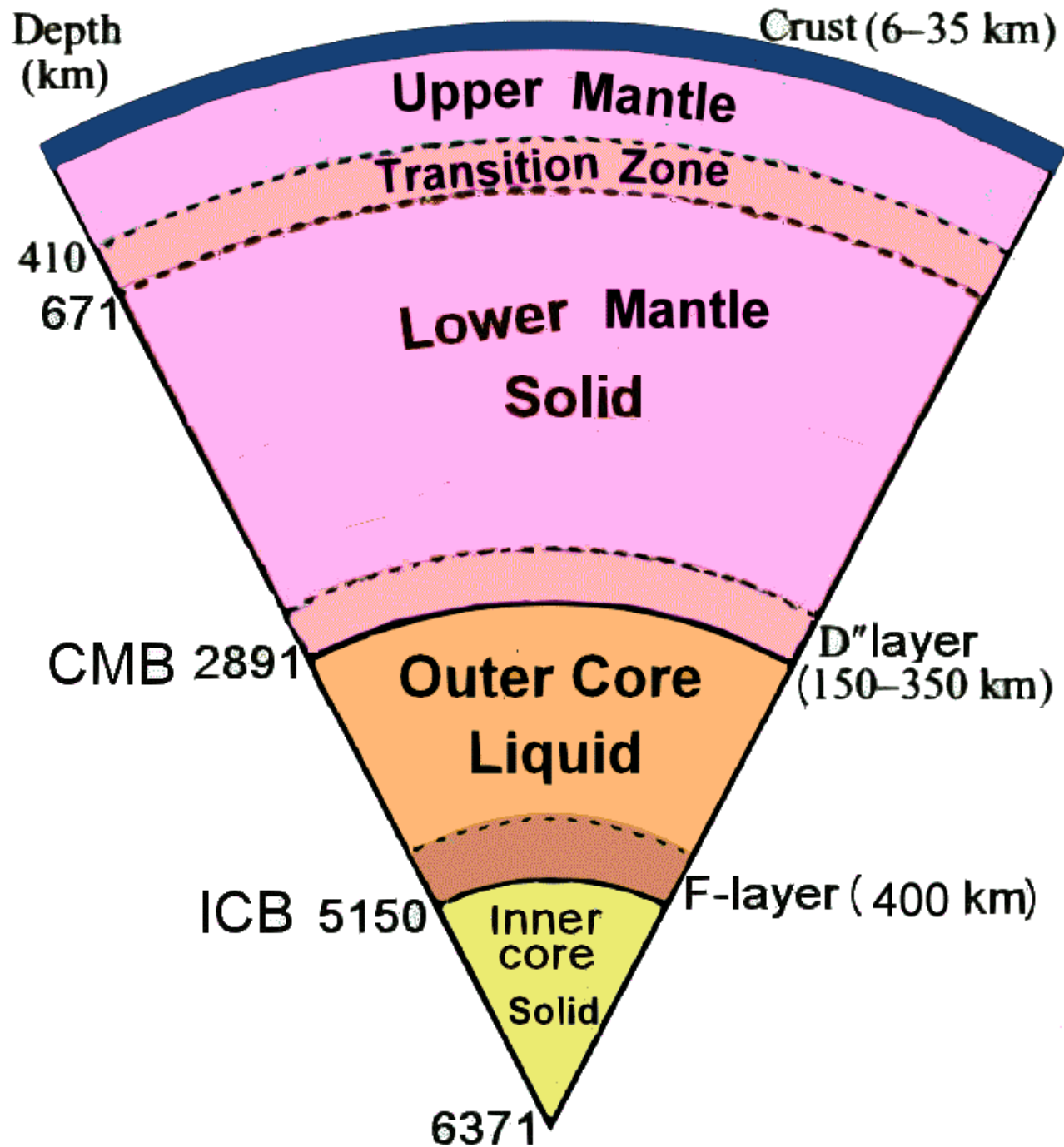

Structure of the Earth

In the PREM the density jumps significantly at the CMB, all investigations cannot confirm the data directly, so, research about the interior constitution of the Earth is needed, especially at the CMB. There are some arguments in the topic of the CMB.

Different views at the Earth's interior

1. The CMB is the boundary of Ramsey's phase-change not silicates and iron core interface.
2. Bulk modulus keeps constant that density distribution should be continuous at the CMB.
3. Seismic reflection amplitudes show only a phase-change at the CMB.
4. Topographic map of CMB height difference more than 10 km shows the both sides of CMB change phases of materials.
5. Heat flow of the Earth reveals the great convection cell is from the crust to F-layer of the core.
6. Platinum has come all the way from the core to ground shows a single convection cell.
7. A 8 km diameter of natural fission reactor at the Earth's center generates the fission heat.
8. The low velocity gradient and velocity jump in F-layer displays the components between both sides of ICB are different.

CMB is the boundary of Ramsey's phase-change not silicates and iron core interface

Ramsey (1948) and Lyttleton (1973) have challenged the concept of an iron core. They suggest that the silicates (iron silicates and magnesium silicates) are the main composition of the mantle. Because the solid mantle under high temperature and high pressure at the CMB, the mantle silicates undergo phase-changes, which are called Ramsey's phase-changes, a solid phase changing into a liquid phase in the top core, to produce the material of high density, low melting point and electrical conductivity. Ramsey's hypothesis is still accepted by a few geophysicists for several reasons.

Bulk modulus keeps constant that density distribution should be continuous at the CMB

In 1965, Knopoff showed that across a phase transition near the surface of CMB, one can predict that the bulk modulus K increases by the increasing of the density ρ ; in such a way, the ratio $K/(\rho^{7/3})$ is kept constant. From the models, the bulk modulus remains essentially unchanged across the CMB that is difficult to account for a large density jump from about 5.57 g/cm^3 to about 9.90 g/cm^3 in the PREM. On this basis, it is difficult to argue in favor of the density distribution to be smoothly continuous at the CMB and the composition of outer core is silicates.

Seismic reflection amplitudes show only a phase-change at CMB

In 1968, Buchbinder studied the variation in amplitude, with epicentral distance Δ , of the reflected phase PcP. He found that the amplitude-distance curve, which displays a minimum at $\Delta = 32^\circ$, was not consistent with the computed reflection amplitudes for a solid-liquid interface if the previously accepted values of V_p and density were employed. A model is proposed by Buchbinder that is consistent with the observed amplitudes, provides no discontinuity in density between the low mantle and the core. Such a model may arise if there is considerable mixing of the core material with the lowermost mantle, and vice versa.

The core is mainly composed of iron just an assumption

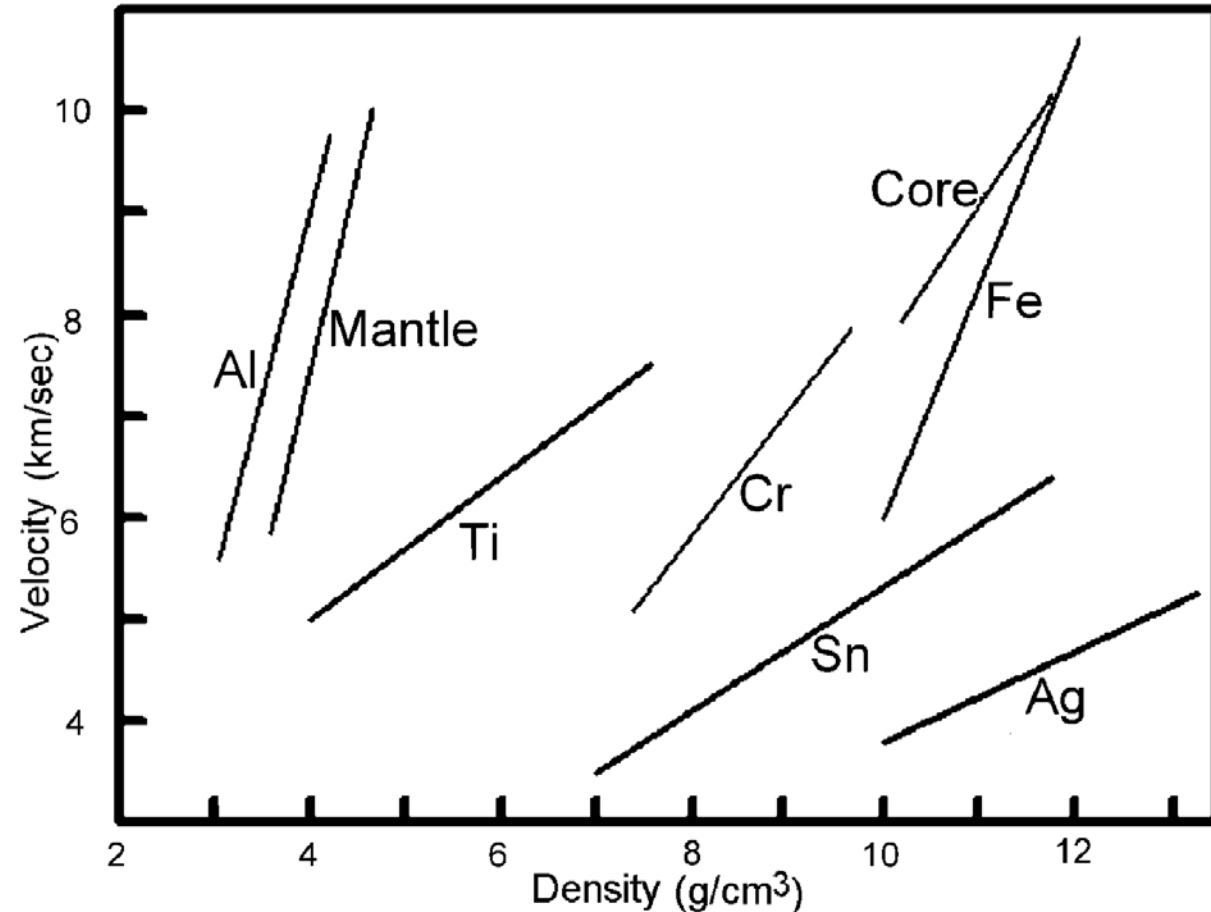

The Diagram of Birch

The materials of Earth's interior based on "Birch Diagram", which was inspected the relations of "velocity / density" in each element, to indicate the composition of matter that is considered as the "golden rule". By "Birch Diagram" speculated that the core is mainly composed of "iron", but that's just an assumption, we cannot examine it.

The proportion of the quantity of the iron in the core is not reasonable

The composition of the Earth by the proportion of the meteorites that fall to the ground, can be found the more stone meteorites on Earth, iron meteorite contains only about 15%. The Earth basically gathered from small particles of the same cold solid ingredients. If we calculate the mass of iron core part of the Earth by PREM that is about 1/3 of the Earth's. It is share of iron meteorite much large than the iron meteorite containing, apparently not reasonable. The outer core need not be filled with iron. Although some hypothesizes such as the existence of a D" layer in the lower mantle and iron combined with oxygen as the primary alloying constituent of the outer core are suggested, but there are also some discrepancies in the interior of the Earth. It is worth exploring.

Study on structural model of the Interior of the Earth in the CMB

Discussion in the problems of CMB, we can find the density jump is too much. Dates back to the 1960's, the development documents of Earth Science can be found that there were two different views of Earth scientists. One considered the materials in the both sides of CMB should be large density jump, but another inferred the density distribution in the both sides should be continuous. Later on scientists invented "diamond pad compression method" and the iron and oxygen were compressed at the calculated pressure and temperature near the CMB that both materials can be combined together successfully. Then all scientists gave up research for continuous density. But the matter near the CMB is just presumed that we cannot confirm it.

Detail of Diamond Anvil Cell

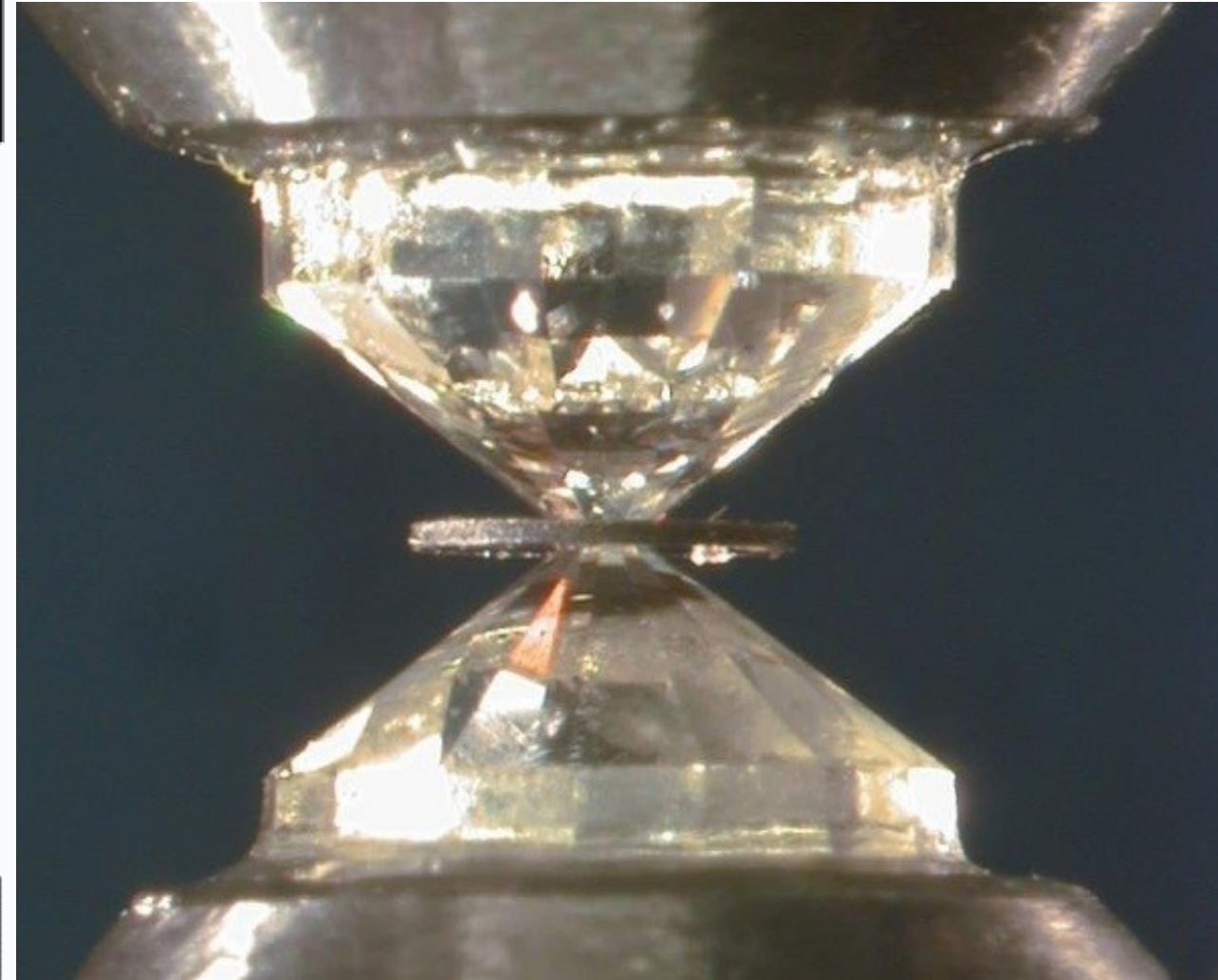
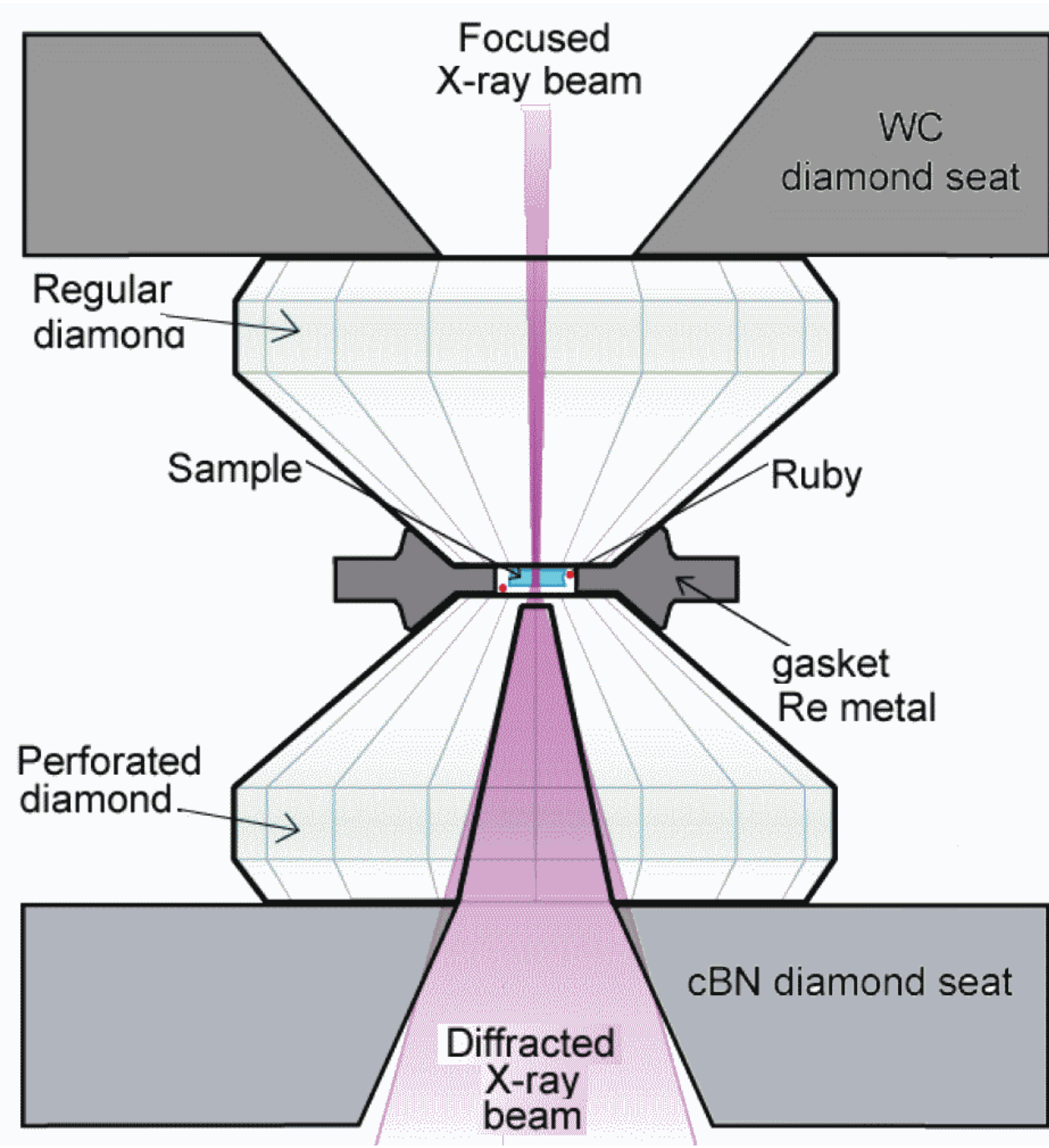

Photo of Diamond Anvil Cell

3-dimensional topographical map of CMB height difference more than 10 km drawn from earthquake data

Geophysicists recorded on Earth more than 15,000 times magnitude 4.5th-class earthquake data, input seismic laboratory computer, drawing the three dimensional topographical map of the Earth's Interior, and computer tomography X-ray photograph, produced the CMB topography, which is found in boundary of solid mantle and liquid outer core. The undulations of CMB in regions from 3,000 km to 6,000 km, denote the irregular high mountains and deep valleys. The amplitude of the boundary is about ± 6 km, in other word, the height difference more than 10 kilometers, even higher than the world's highest peak—Mount Everest, and in a very unstable state. Scientists draw different topographic map of CMB as following:

The three-dimension topographic map of CMB

1987 Morelli and Dziewonski

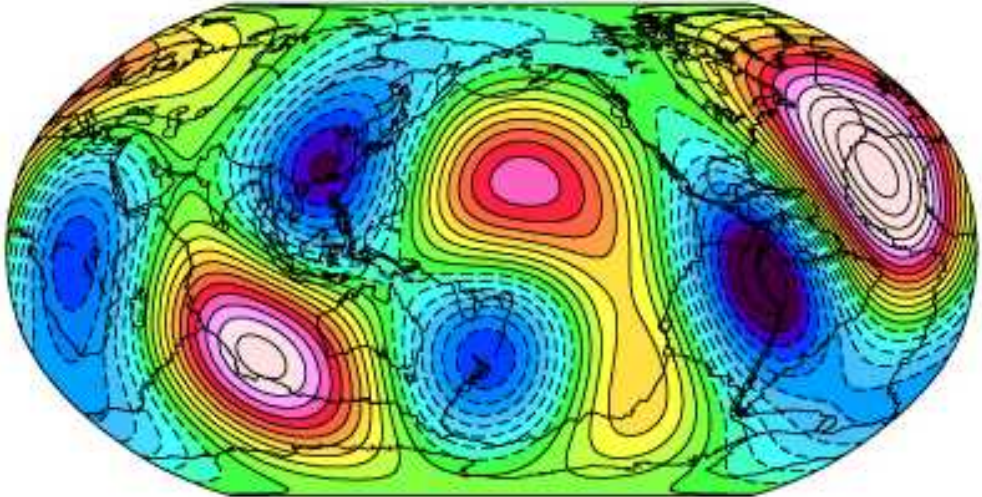

1993 Rodgers and Wahr

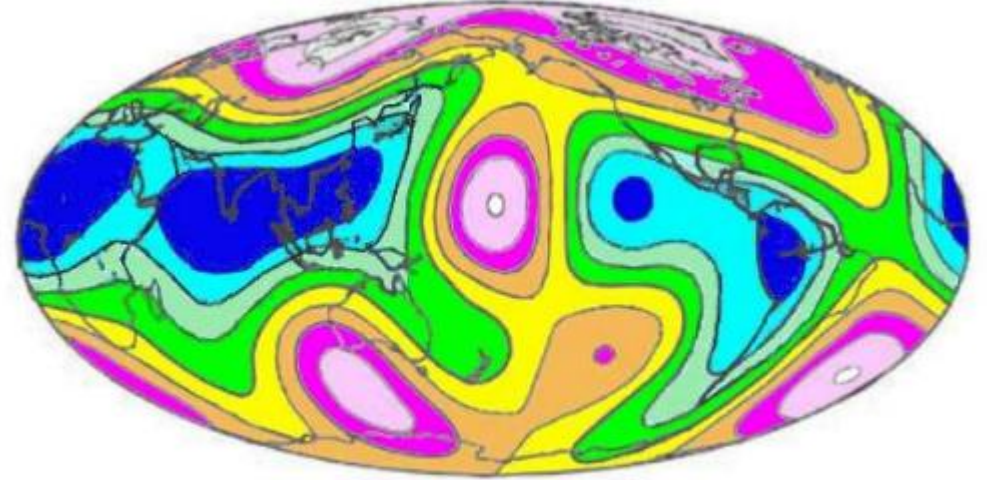

1989 Doornbos and Hilton

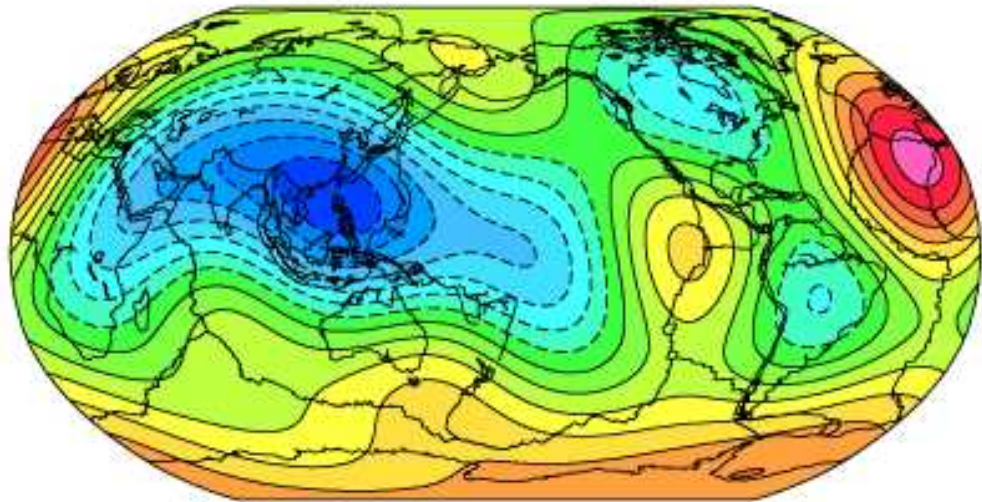

1997 Obayashi and Fukao

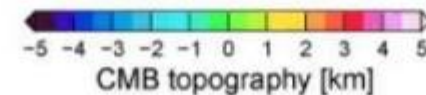
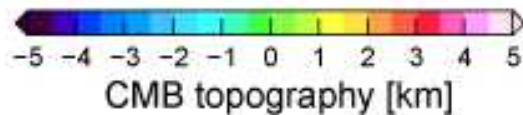
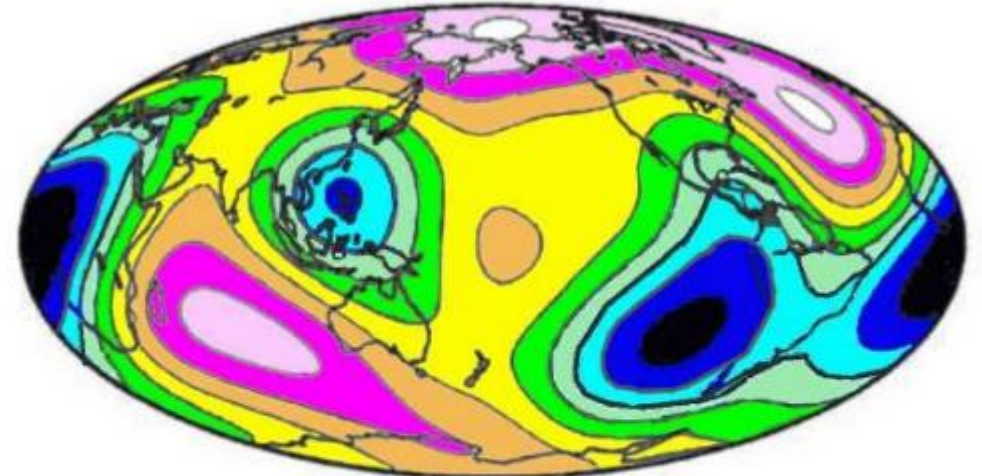

The three-dimension topographic map of CMB

2008 Masaki Yoshida

(a) cmbT

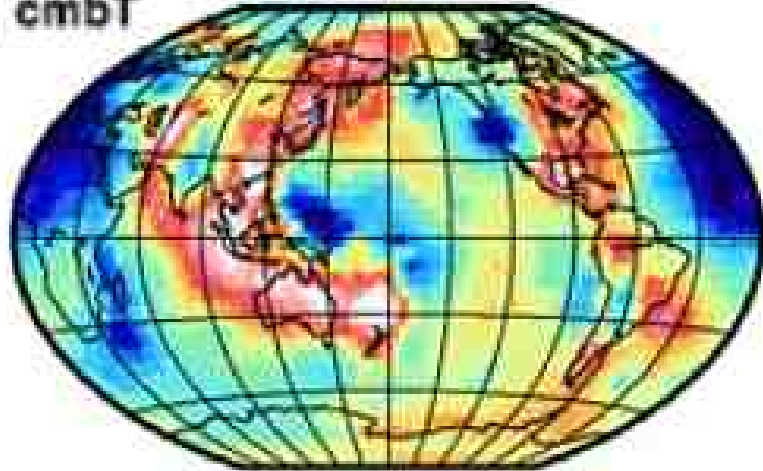

(b) cmbTG

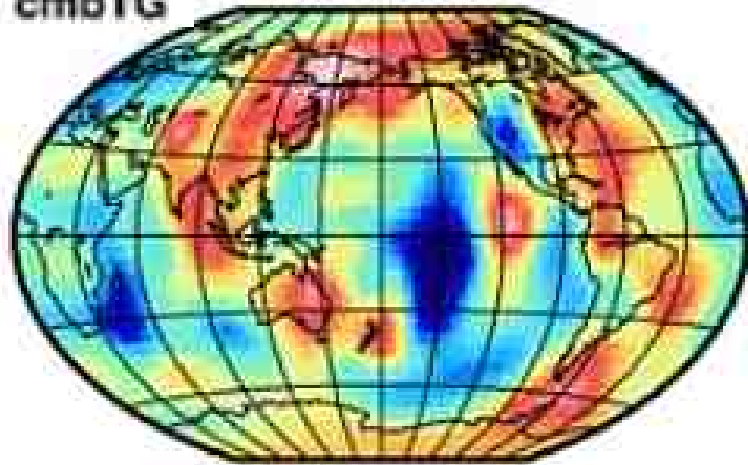

2014 Soldati, Boschi, Mora and Forte

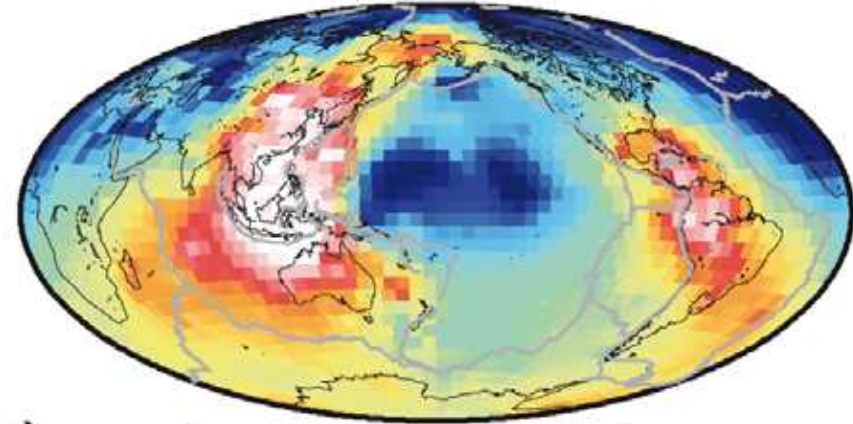

(a) *Tomographic inversion*

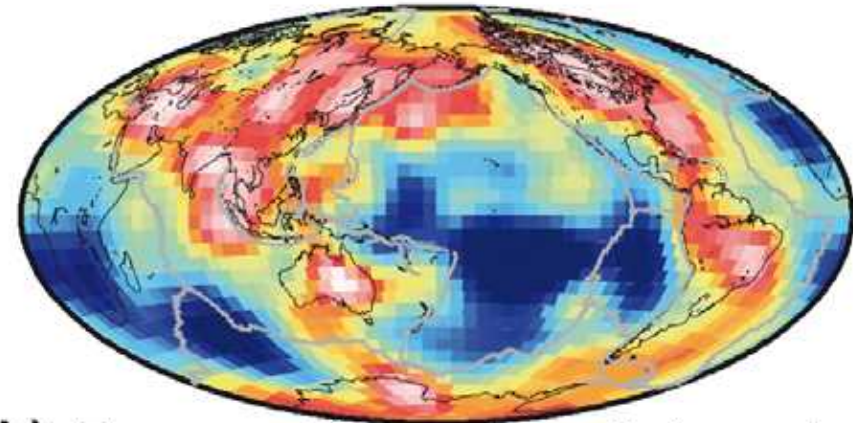

(b) *Tomographic-geodynamic inversion*

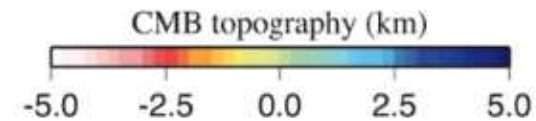

Summary of some methods for studying the CMB topography

[Schlaphorst *et al.*, 2016]

Study	Method / seismic phases	Topography amplitude
Doornbos (1978)	PKP precursors	\pm few 100 m
Hager et al. (1985)	Geoid modelling	\pm 1.5 km
Bowin (1986)	Inversion	\pm 1.5 km
Gwinn et al. (1986)	Geodetic nutation observations	\pm 0.5 km
Morelli & Dziewonski (1987)	PcP, PKPbc	\pm 6 km
Neuberg & Wahr (1991)	PcP	\pm 3 km
	PcP, PKPab PKPbc, PKPdf	\pm 10 km, \pm 30 km
Earle & Shearer (1997)		\pm 0.35 km
Garcia & Souriau (2000)		\pm 4 km
Sze & van der Hilst (2003)	PcP, PKPab, PKPbc, PKKPab, PKKPbc	\pm 5 km
	PKPdf	\pm 13 km
Yoshida (2008)	Numerical modelling	\pm 8 km
Steinberger & Holme (2008)	Mantle flow model	\pm 3 km
Tanaka (2010)	PcP, P4KP	\pm 2 km

Topography of CMB reveals both sides at CMB to be the same materials

It is obviously in terms of the geodynamic processes that only the vertical interactions of material and the temperature between the lowermost mantle and the outer core are the main cause, but lateral variations are not. In order to maintain the 10 km of relief, the density difference between the liquid state and the solid state at the CMB must be very small. There is a significant suggestion that the density of the materials between the both sides at the CMB must be similar or equal; i.e., the hypothesis that the same materials between a solid mantle and a liquid core change states with each other at the CMB to produce topography of the CMB more than 10 km relief.

Diagram of Earth's plume model and plate model

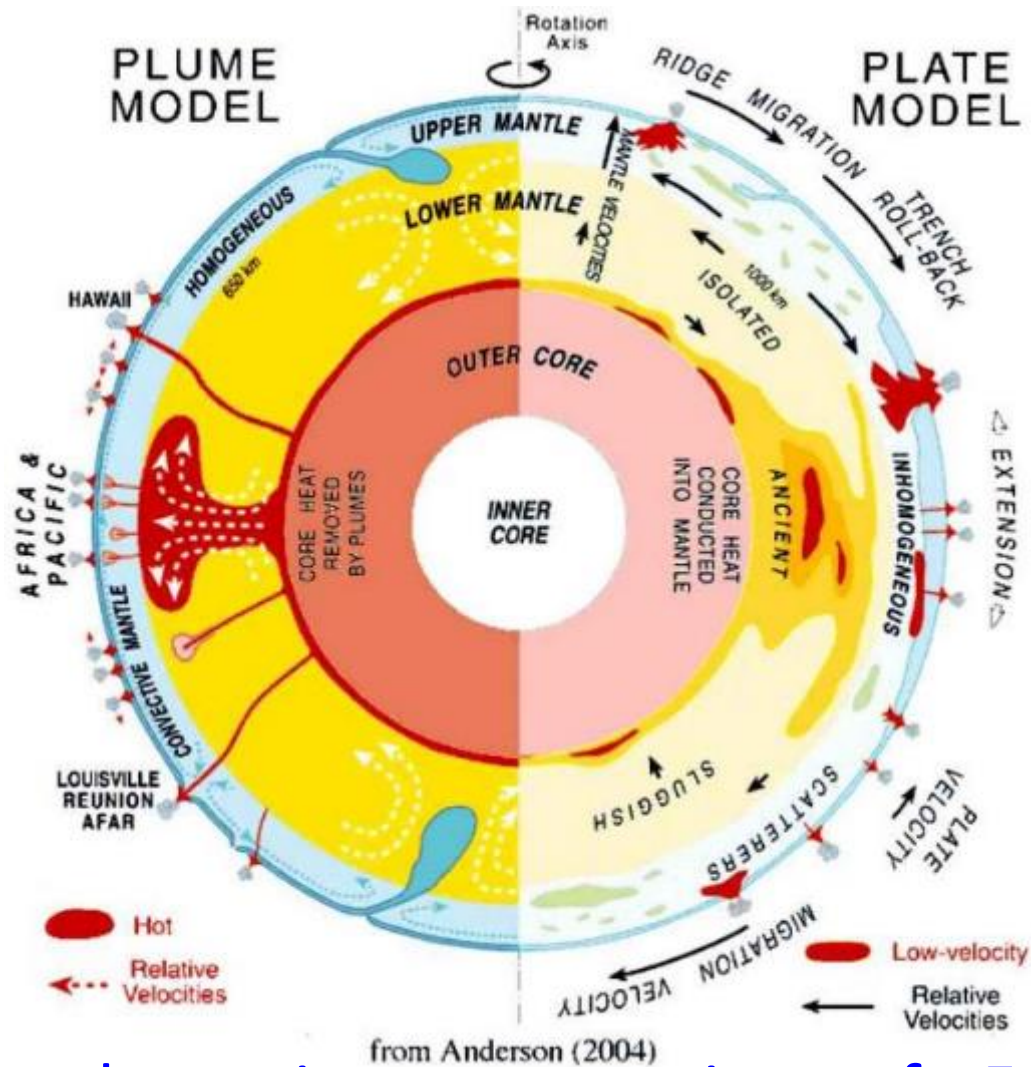

There are two largely independent convective processes occur in the mantle. 1. *Mantle plumes*, which carry heat upward in narrow, rising columns, driven by heat exchange across the core-mantle boundary to the crust. 2. The broad convective flow associated with *plate tectonics*, which is driven primarily by the sinking of cold plates of lithosphere back into the mantle.

A schematic cross-section of Earth showing the hypothesis of mantle plumes versus the plate tectonics.

Seismologists found 28 hot plumes rose from the core to the ground

American seismologists have used a similar magnetic resonance imaging (MRI) tomography, unprecedented explored thousands of kilometers deep under the Earth's surface, found 28 mantle plumes continued upward from the CMB to the ground. When plume reached the bottom of the lithosphere, radially outward flow formed like a mushroom-shaped structure, and at the center of hot plume pour out to the ground to form hotspots of volcanoes, many of which directly supply heat of hotspots. These mantle plumes provide the direct evidence, which show a mantle plumes form volcanic hotspots, such as Iceland and chain islands of Hawaii. Heat flow of Earth's interior release to ground through the mode of mantle plumes.

Three types of hotspot in the Earth's mantle

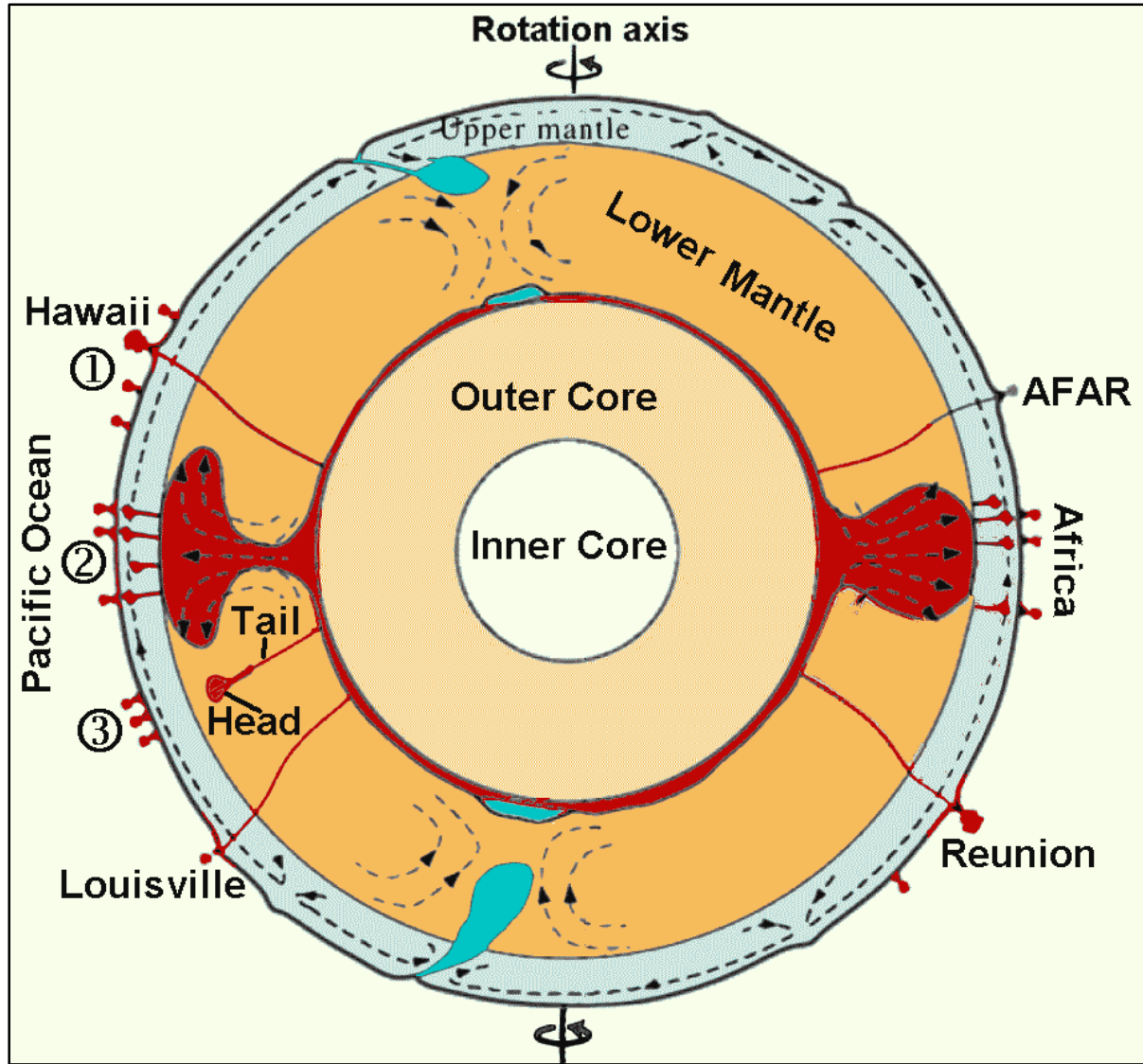

A schematic cross section of the earth showing three sources of plumes. ①. Plumes originating at the lower mantle boundary layer D". ②. Plumes originating from the tops of domes near the transition zone. ③. Plumes with a superficial source. At present only plume tails, and no plume heads are active.

Three distinct types of hotspots in the Earth's mantle [Courtilot *et al.* 2003].

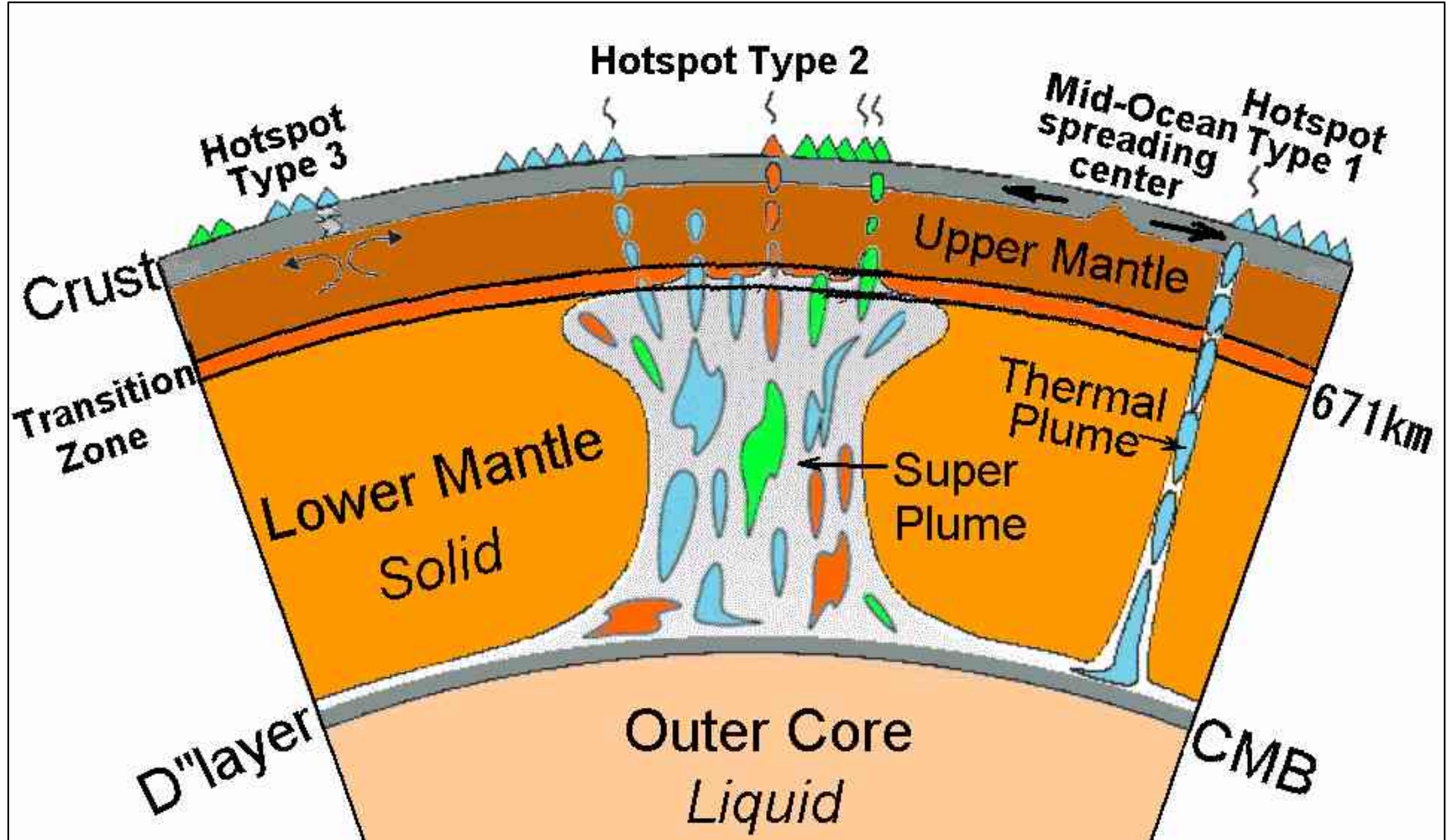

The three types of hotspot in the Earth's mantle [Anthony, 2011].

Mantle plumes rise from Earth's core

Various lines of evidence have been cited in support of mantle plumes. Mantle plumes are tubes of hot rock rising from Earth's core, many of them underneath known volcanic hot spots at Earth's surface. The plumes are fatter than expected, which means that they carry more heat away from Earth's core, an indication that plumes are important for cooling the planet of Earth.

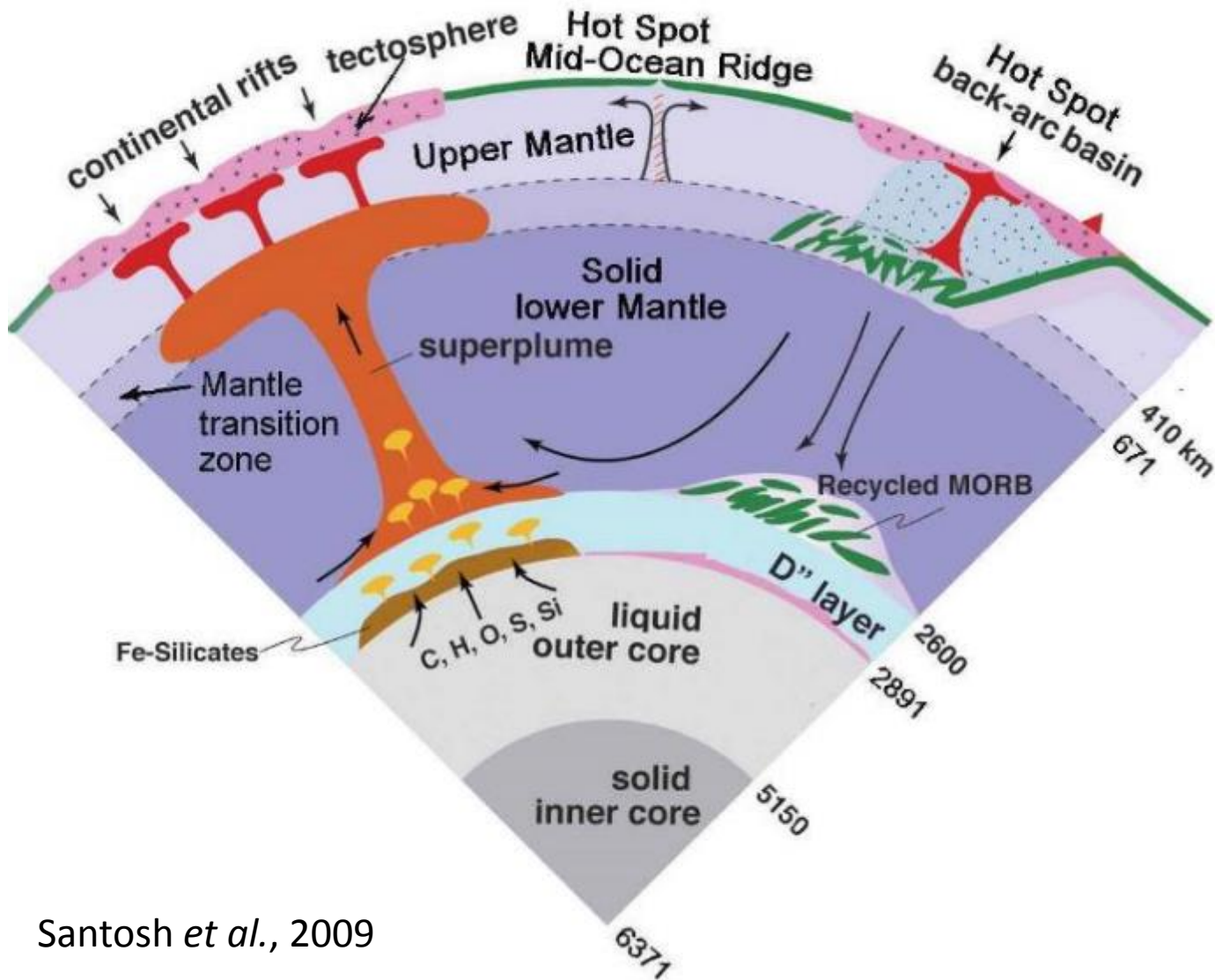

Santosh et al., 2009

Mantle plumes rise from Earth's outer core

Plate models have been accepted by some geoscientific community

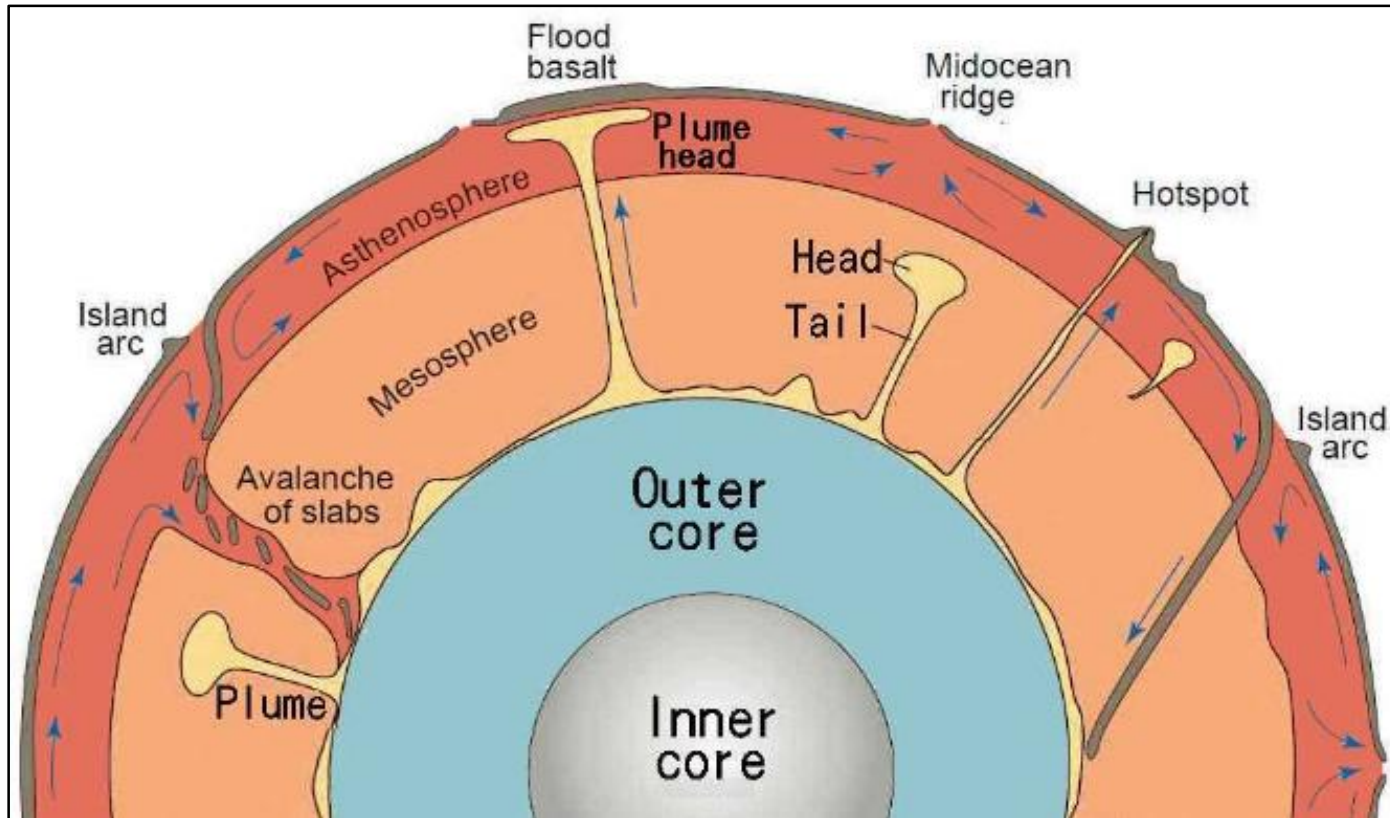

Diagram of Earth's constitution in plume model and plate model

Plate tectonics is a scientific theory describing the large-scale motion of Earth's lithosphere. Tectonic plates build on the concept of continental drift, and has been accepted by the geoscientific community after seafloor spreading was validated.

Subjects of thermal plume and plate tectonics still exist much debate

No plume has yet been found to satisfy all the criteria currently attributed to plumes, adding that the hypothesis has become too flexible, with ad hoc variations tacked on to accommodate any finding. It is still unresolved whether features that have been attributed to plumes are primarily the result of plate tectonics and stress, or fluid dynamics and high temperature, and the factors of plate movement is unclear, and still the subject of much debate. With uncertainty in the areas of lower mantle and outer core, and possible unrecognized complexity, precision in the estimates of CMB heat flux is not yet clearly in hand.

The core is the most abundant in heat flow

The current total heat flow at Earth's surface estimates to be refined and are agreeing at around 43~49 TW. Releasing heat is by nuclear energy of the Earth from the much slower decays of radioactive elements. Most models assume a CI carbonaceous chondrite origin for the Earth, leading to a total heat production in the mantle and the crust of about 20 TW. The heat flow across the CMB can be up to 29 TW that means heat flow in the core is far beyond up part of the Earth. the core is the most abundant in heat flow that is thought to represent power dissipated by the geo-dynamo, and to produce the geo-magnetic field. The heat loss from the Earth's surface is more than the heat getting from the Sun. If the core does not for the continued release of heat, the Earth would have cooled off as Moon or Mars.

Global map of heat flux

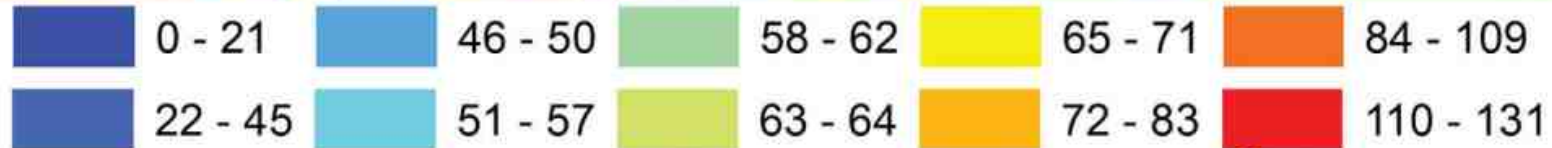
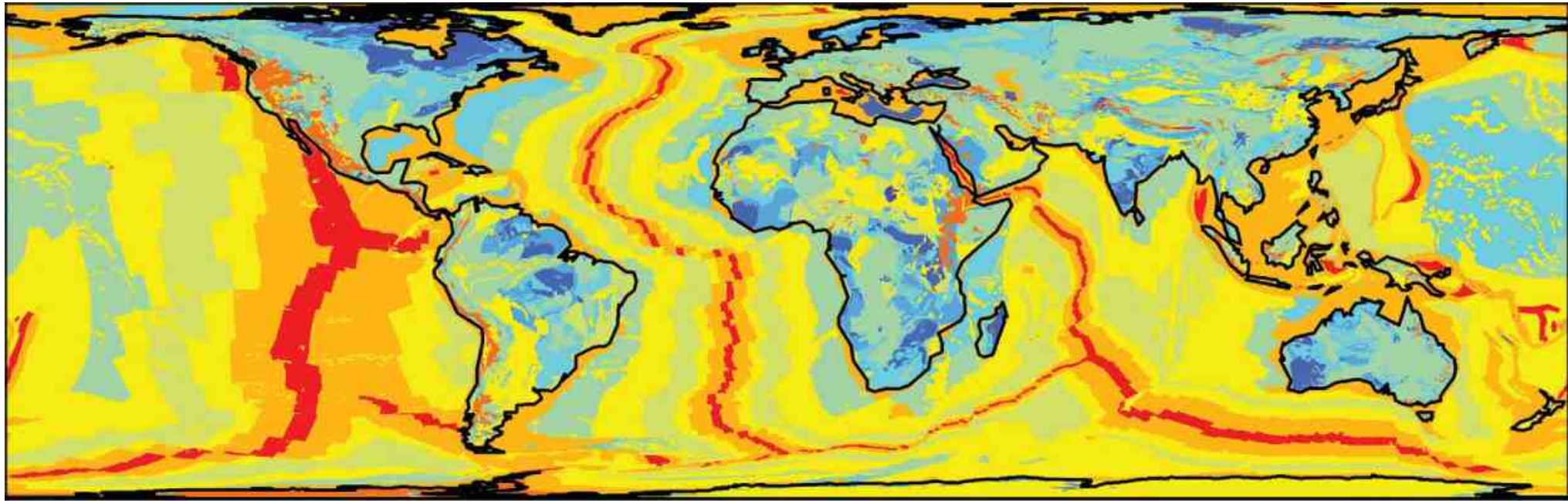

Heat Flow based on Geology (mW m^{-2})

Heat flux from Earth's Interior to the surface, the largest values of heat flux appears consistent with the mid-ocean ridges, and the smallest values of heat flux values occur in stable continental interiors [Davies & Davies 2010].

Core's materials have come all the way to ground

In 1995, at least some of 2 million cubic kilometers of lava spread over parts of Siberia 250 million years ago, which came from the lowermost mantle. A small fraction of the valuable metal platinum under 1 %, discovered under the frozen wastes of Siberia, may have come from the core. From the US and Russia report, the ratio of helium-3 to helium-4 in Siberian rocks is up to 12.7 times the atmospheric value that indicates the lava came from the deep interior of the Earth. Also high levels of osmium-187 have been found in sulphide rocks in the deposits that indicates some materials come from the metallic core.

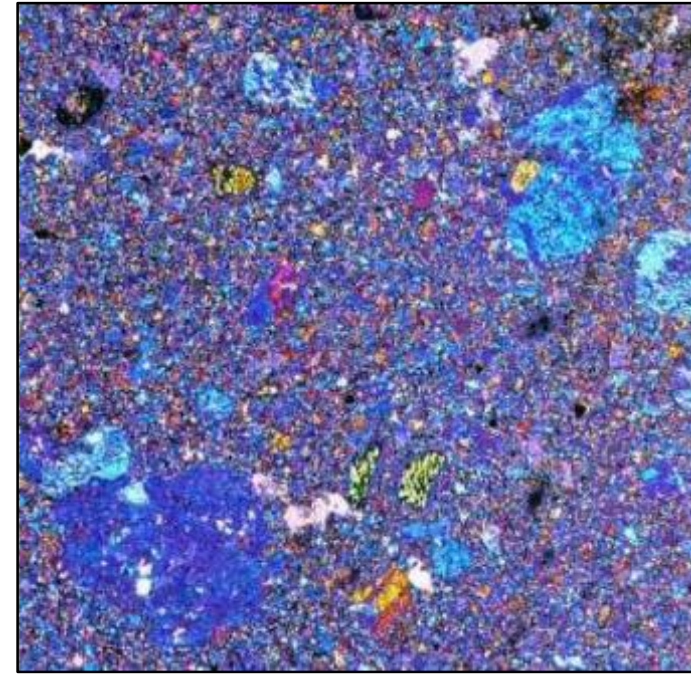

In wastes of Siberia a small fraction of platinum has come from the core [Hecht 1995].

Natural nuclear fission reactor in the Earth

In 1956 Kuroda applied nuclear reactor theory and demonstrated the feasibility that seams of uranium ore could engage in neutron-induced nuclear fission chain. In 1972, Francis Perrin discovered the intact remains of a natural nuclear fission reactor, which took place approximately 1.7 billion years ago in a uranium mine at Oklo of Gabon that conformed the nuclear reactor theory. Oklo mine consists of 16 sites at which self-sustaining nuclear fission reactions.



In 1972, the intact remains of a natural nuclear fission reactor in a uranium mine at Oklo of Gabon (NASA, 2005).

A diameter of 8 km natural fission reactor at the Earth's center

In 2002, Oak Ridge lab of United States Federal Energy in National Geographic Society report a new achievements in scientific research that 6371 km below the surface of the Earth's Center has a diameter of 8 km, consisting of uranium and plutonium fast breed natural fission reactors, which are the source of energy for all life on Earth. The theory is the main evidence that researchers observe radiation emitted when the volcano erupted the magma contains a high degree of ^3He in the area of Hawaii and Iceland spewed by the seabed. This isotope can only be generated in a nuclear fission reaction. In the geocentric nuclear fission reactors emit energy that impel inner isotope of ^3He rising from the Earth's center to ground.

The magma from fluid core rises upward through mantle to pour out at cracks of the Earth's surface

The hottest point is the center of Earth about 7000°C , and in the fluid core about 6000°C , at the CMB about 4000°C . The abundant heat flow must from fluid core leaks out into mantle. Thermal plumes are tubes of hot rock rising from Earth's core, and carry more heat away, a great quantity of magma heated by the extreme temperatures in the outer core solidifies into rock and produces the heat of solidification at the CMB. A few quantity of magma absorbing this heat does not solidify, but mixes with masses of rock as honeycombed blobs of rock, rising upward at approximately an inch a year through the mantle to pour out at the cracks of Earth's surface. The heat flow provides the Earth's volcanic eruptions and continental plate's drift of power source, also a source of energy for all life on Earth.

Cold plate in subduction zone may be driven and convection falling through mantle into liquid core

Due to geological processes, the downward migrating masses of cold lithosphere plate in subduction zone of the crust may be driven through convection falling subduction slab all the way through the warmer surrounding mantle to the CMB. The downward masses of descending slab in the cold regions of the low mantle produce a depressions of the CMB and downwelling flow into the outer core. The downward masses of slab absorb the heat of fusion, and melting in the core where viscosity is so high that the molten rock may not diffuse and become heterogeneous mixtures —magma. In the F-layer temperature about $6,000^{\circ}\text{C}$, the downward migrating magma, which already decreases viscosity but rich in iron oxides and Fe, are affected by diffusion, obstruction of the inner core, tangentially geostrophic flow and toroidal flow, so the fluid flows westward, which may causes the geomagnetic secular variation.

A schematic diagram of the great convection cell

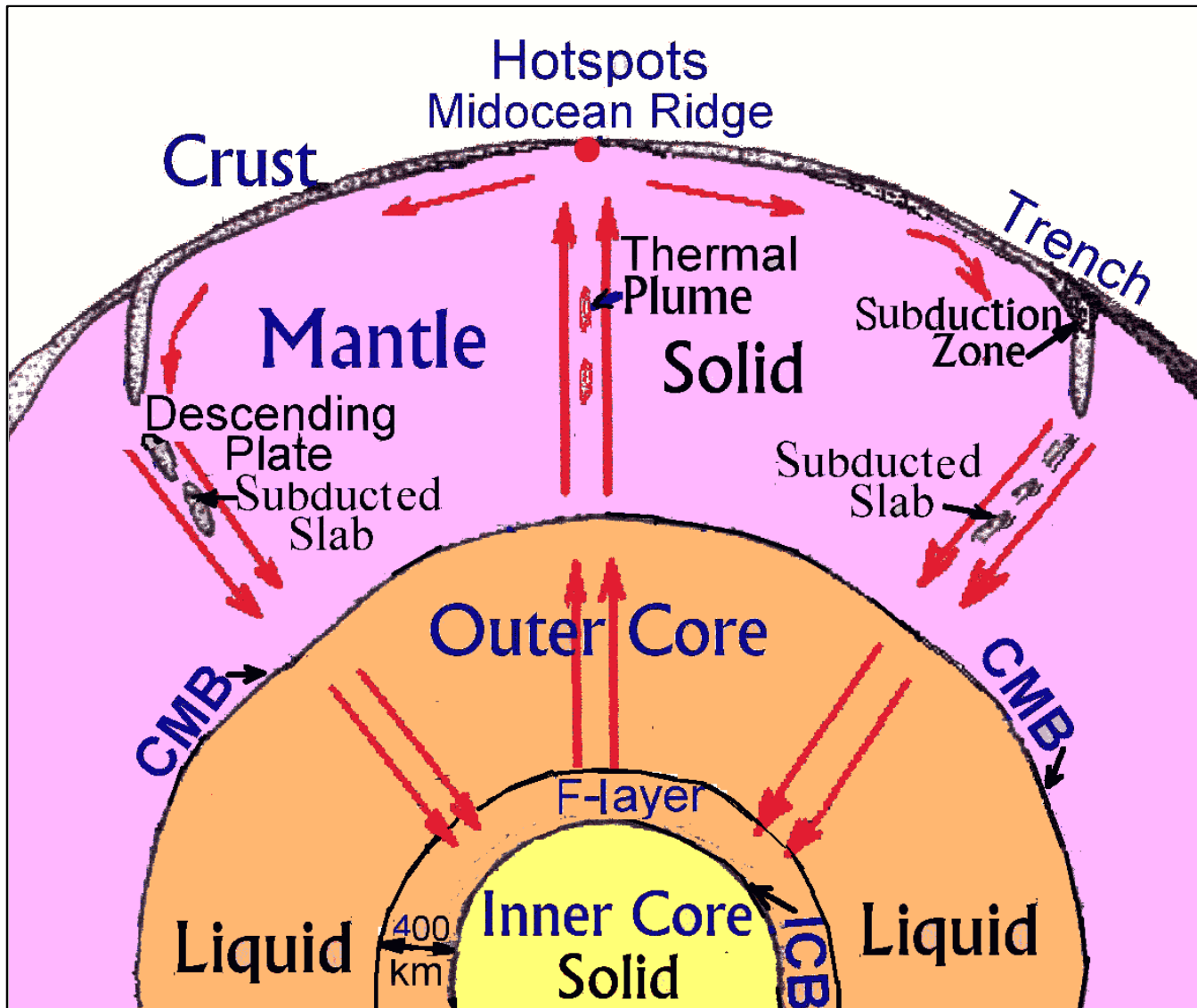

The great convection cell is from crust to outer core.

The thermal plume from the outer core bring some materials such as helium-3, osmium-187 and a small fraction of metal platinum, and accompany with magma to migrates up through the mantle to the crust. Then subducted plate of crust sinks down to the F-layer of the outer core that forms a great convection cell. It is different from double convection cell.

Vp low velocity gradient and sharp velocity discontinuity in F-layer indicate different components

Scientists on the core study of seismic wave velocity and amplitude, have suggested that a 400km wide circle of F-layer just above the ICB, contains the high separated solutions.

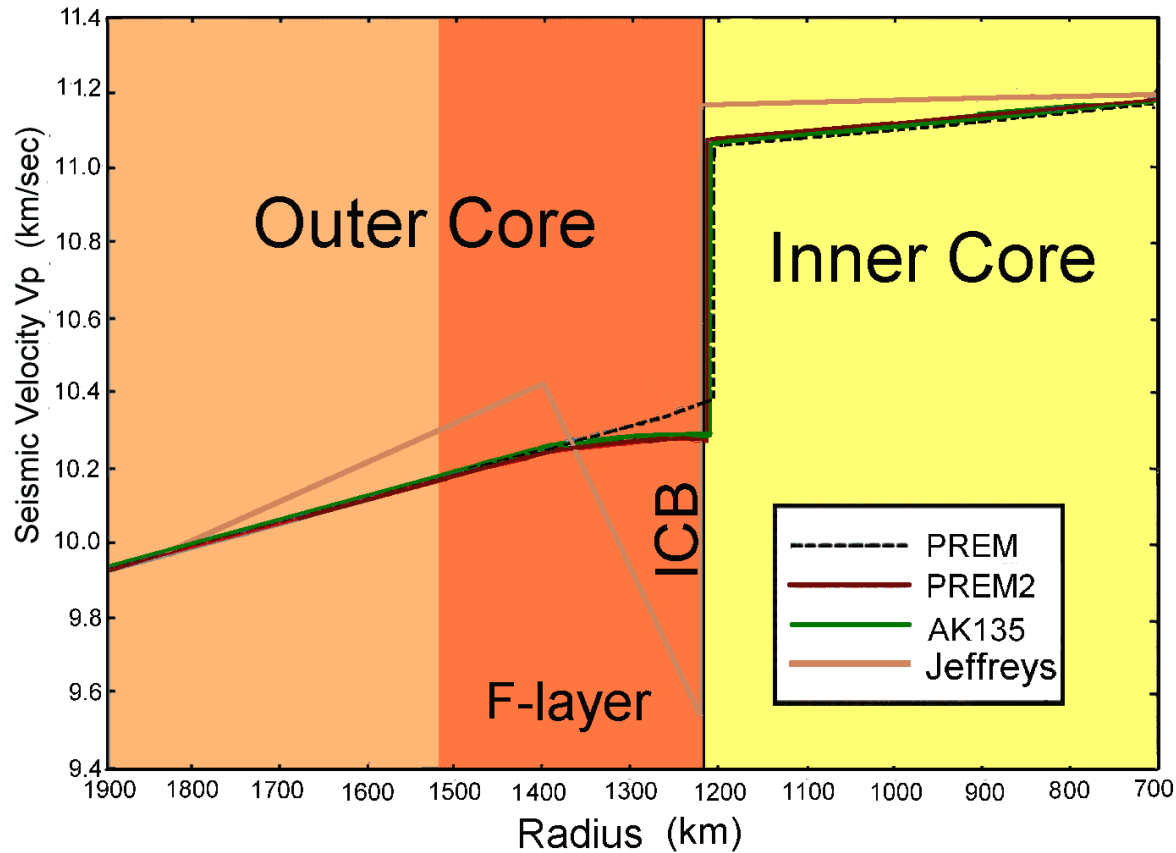

Variation chart of seismic wave velocity Vp in F-layer

contains the high separated solutions. Variation of compressional wave velocity Vp versus radius through the core showing the anomalous F-layer of the outer core. According to seismic models of PREM2, AK135 and Jeffreys denote the low velocity gradient in F-layer and a sharp velocity discontinuity at ICB that indicate a little different properties of component between the core and the mantle.

The inner core should be not a rigid spheroid

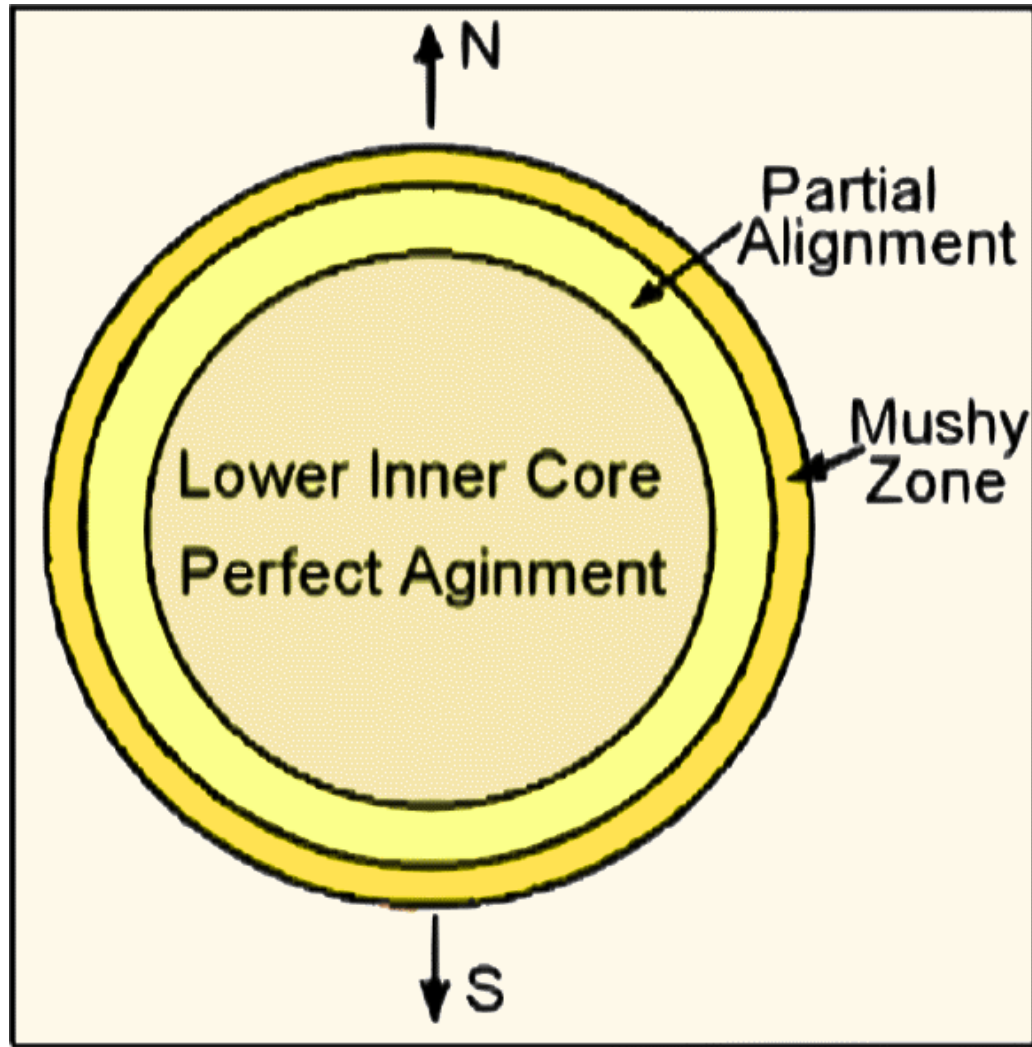

A schematic figure of inner core structure

Study provides evidence for a shear velocity gradient at the top of the inner core. A thin mushy zone develops underneath the inner core boundary while the outer core material falls onto the inner core. The liquid could arise from the presence a "mushy zone" of dendrites or a mixture of elements other than iron that exist in liquid form under inner-core conditions. So, the inner core should be not a rigid spheroid.

Interpretation of more than 10 km height difference of topographic map in CMB

According to mechanics, although the velocity of downward migrating slab plate is low, but its mass from the crust to the CMB is so large that downward momentum has a great quantity. In the liquid outer core, there is no rigid body having enough mass to counteract the downward momentum, so the molten rock sinks all the way into the F-layer. The downward momentum is counteracted merely by the solid inner core, but the solid core is not hard solid crystals. The ICB after accepting a downward momentum generates the pressure and spreads into the earth's center, and pushes out on the relative opposite side of inner core, forms the protruding ICM and the unsmooth CMB too.

1987 Dziewonski's topographic map of CMB in the Earth's interior is taken as an evidence

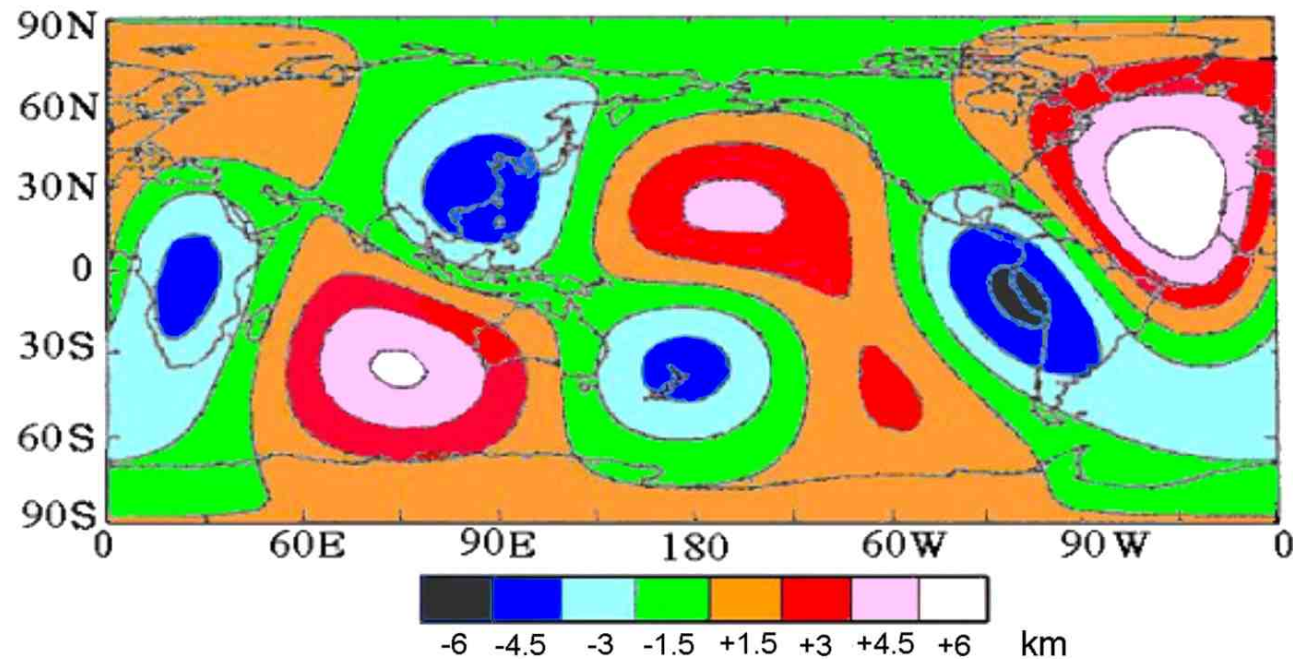

Topography CMB obtained by inversion of the combined PcP and PKP_{BC} Data set. (Morelli and Dziewonski 1987).

The phenomenon can be inspected by the three-dimension topographic map in the Earth. In the CMB, it is concaving from New Zealand, but protruding in the North Atlantic Ocean, and concaving under the west coast of South America, else protruding in region of western Australia and near the Indian Ocean, and concaving under south Africa, also protruding in north Pacific Ocean too.

The higher the temperature the more the polymerization losses of crystalline mineral

The higher the temperature under which common minerals are produced, the lower the polymerization is and vice versa. The closer the crystal minerals of the mantle under the temperature and pressure are to the core, the more the polymerization losses of crystalline mineral. Then the bonding forces of mineral compound are destroyed and the crystallization gradually diminishes. Olivine is an important rock of the Earth. Quartz is a mineral of olivine. After heating, quartz, the four oxygen of the silicon oxygen tetrahedron and four different structures of the silicon oxygen tetrahedron, such as tectosilicates are gradually reduced to phyllosilicates, inosilicates, cyclosilicates, sorosilicates and nesosilicates respectively. Nesosilicates are the crystal tetrahedron of silica mineral, a basic structural unit of minerals.

The temperature profile of Earth's interior

The temperature profile of Earth interior: the hottest point is the center of Earth about 7000°C , about 6000°C in the F-layer and about 4000°C at the CMB.

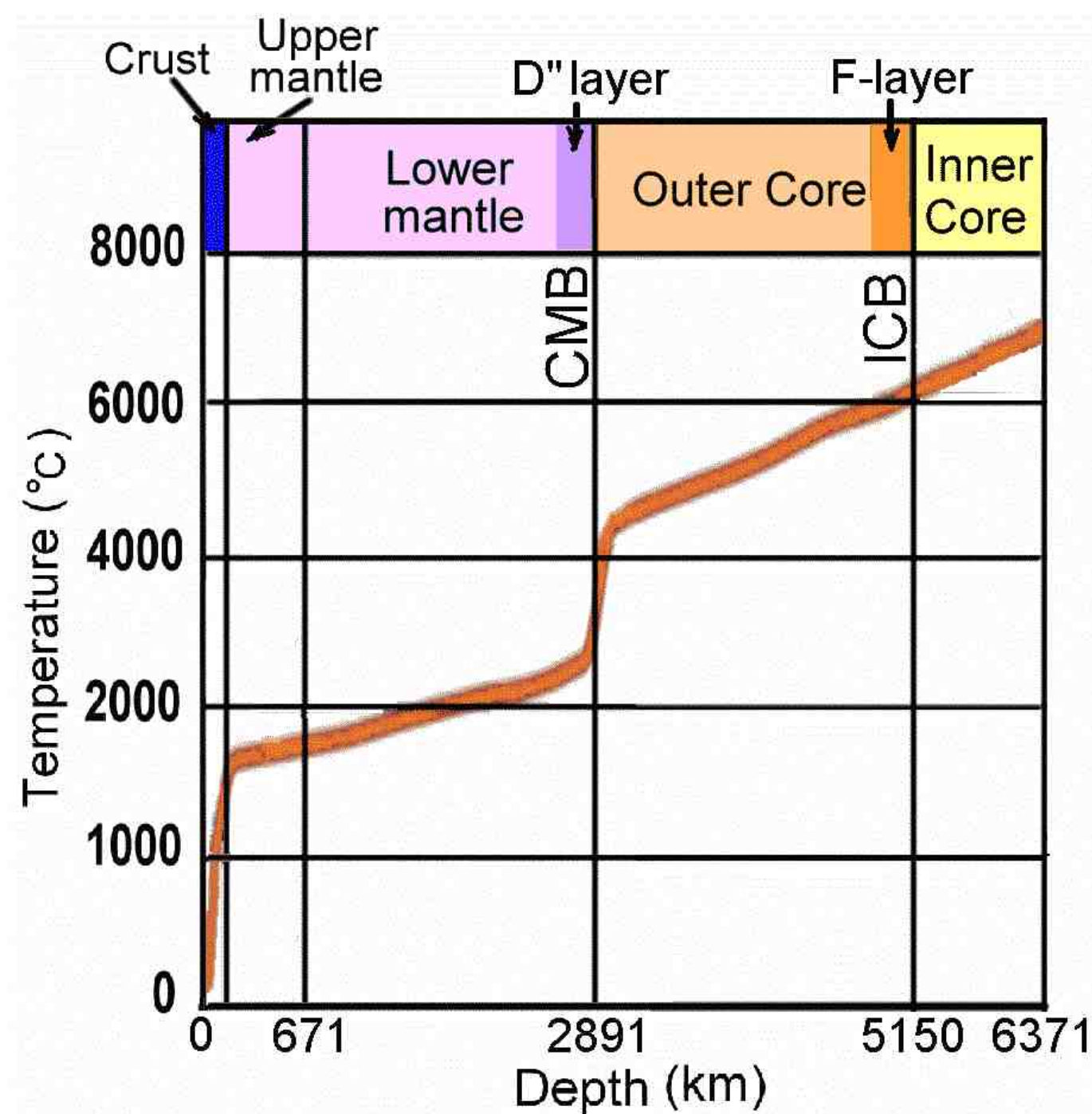

In F-layer magma becomes a mixture of oxides

In the F-layer of the deeper core, the high temperature about 6000°C , polymerization may cease completely, and mostly bonding power of ions loses, only the electronic bonding force exists. All the ions and molecules may become unbounded. Therefore, the molten rock or magma becomes a mixture of oxides such as FeO , MgO , NiO , SiO_2 , Fe_2O_3 , Al_2O_3 , Cr_2O_3 , etc., and metals such as Fe , Ni , Mn , etc., the chemical components maybe reduce the viscosity, the full fluid oxides and metals are able to flow, and diffuse, float or sink more freely according to its specific gravity, thus allowing mutual oxidation-reduction reactions take place in the F-layer. The light metals take oxygen from heavy metal oxides and the heavy metal oxides are reduced to heavy metal and sink down into inner core.

The chemical reactions in the F-layer of outer core

The oxidation-reduction reactions take place in the F-layer as following :

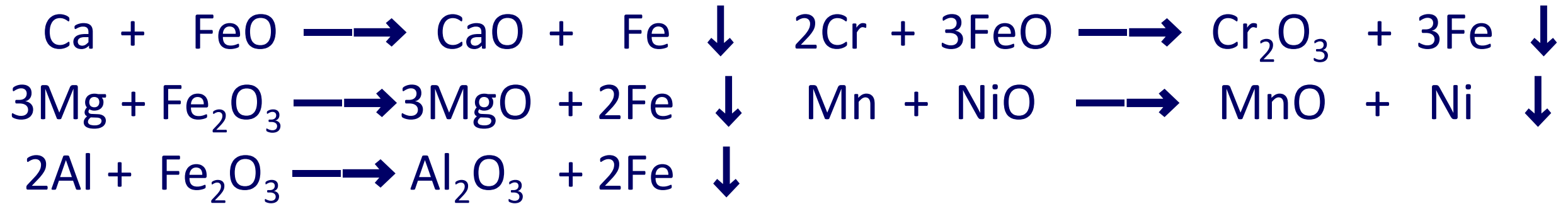

In the F-layer, CaO, MgO, Al₂O₃, Cr₂O₃ and MnO float, and Fe₂O₃, FeO and NiO become iron and nickel, which sink down to be the main component of the inner core. These oxidation-reduction reactions are exothermic processes that produce a great amount of chemical reaction heat.

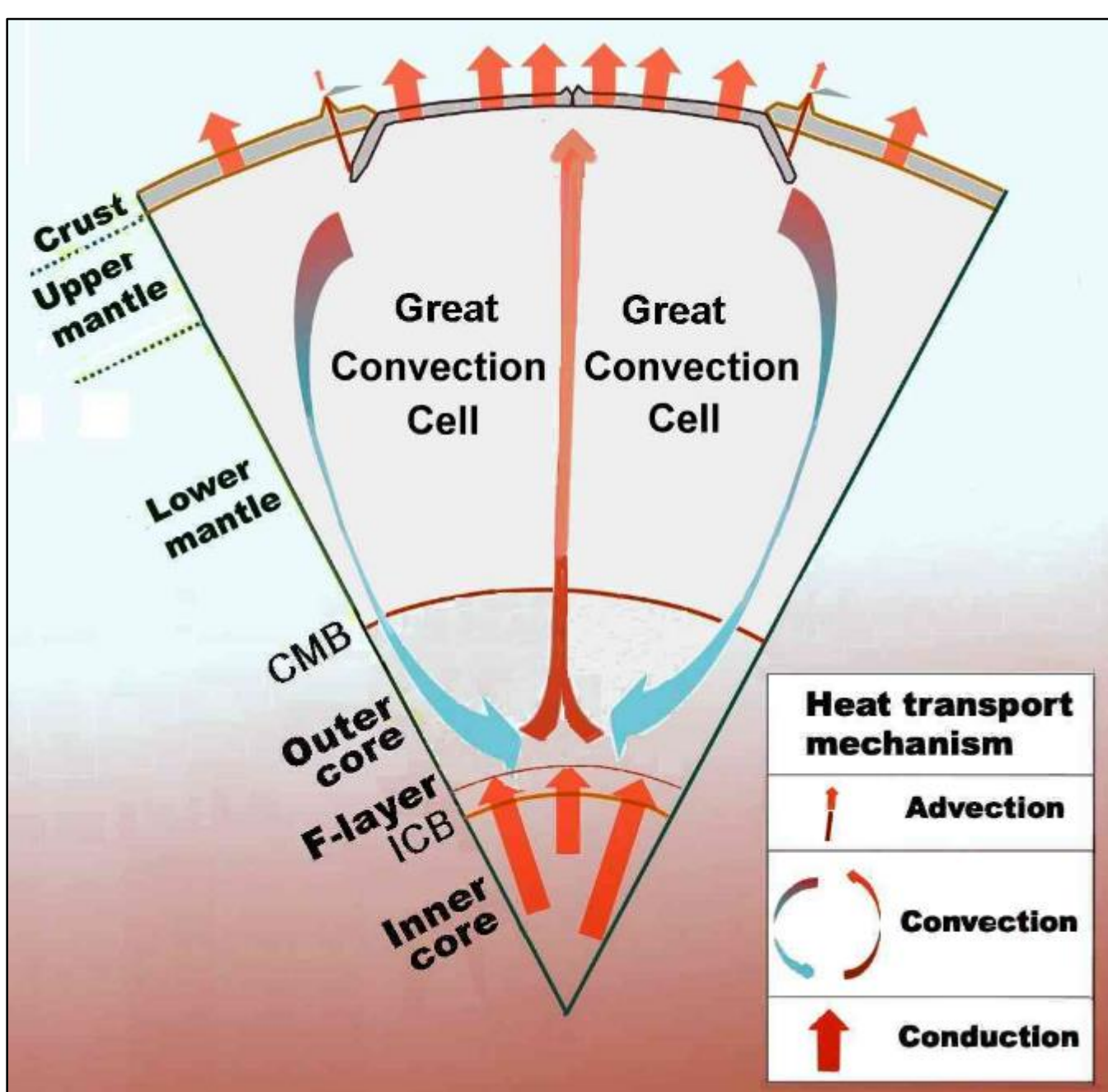

Heat flows of outer core becomes the geodynamo of great convection cell

The heat of chemical reactions in the F-layer combines radiogenic heat in the interior of the Earth and nuclear fission heat in the Earth's center becomes the power sources for the geo-dynamo of great convection cell that causes the convection of materials spanning from the F-layer to the crust.

A great convection cell of heat flow

A schematic diagram of the internal composition of the Earth

We synthesize the relevant reasonable inferences above, and set the internal composition of the Earth.

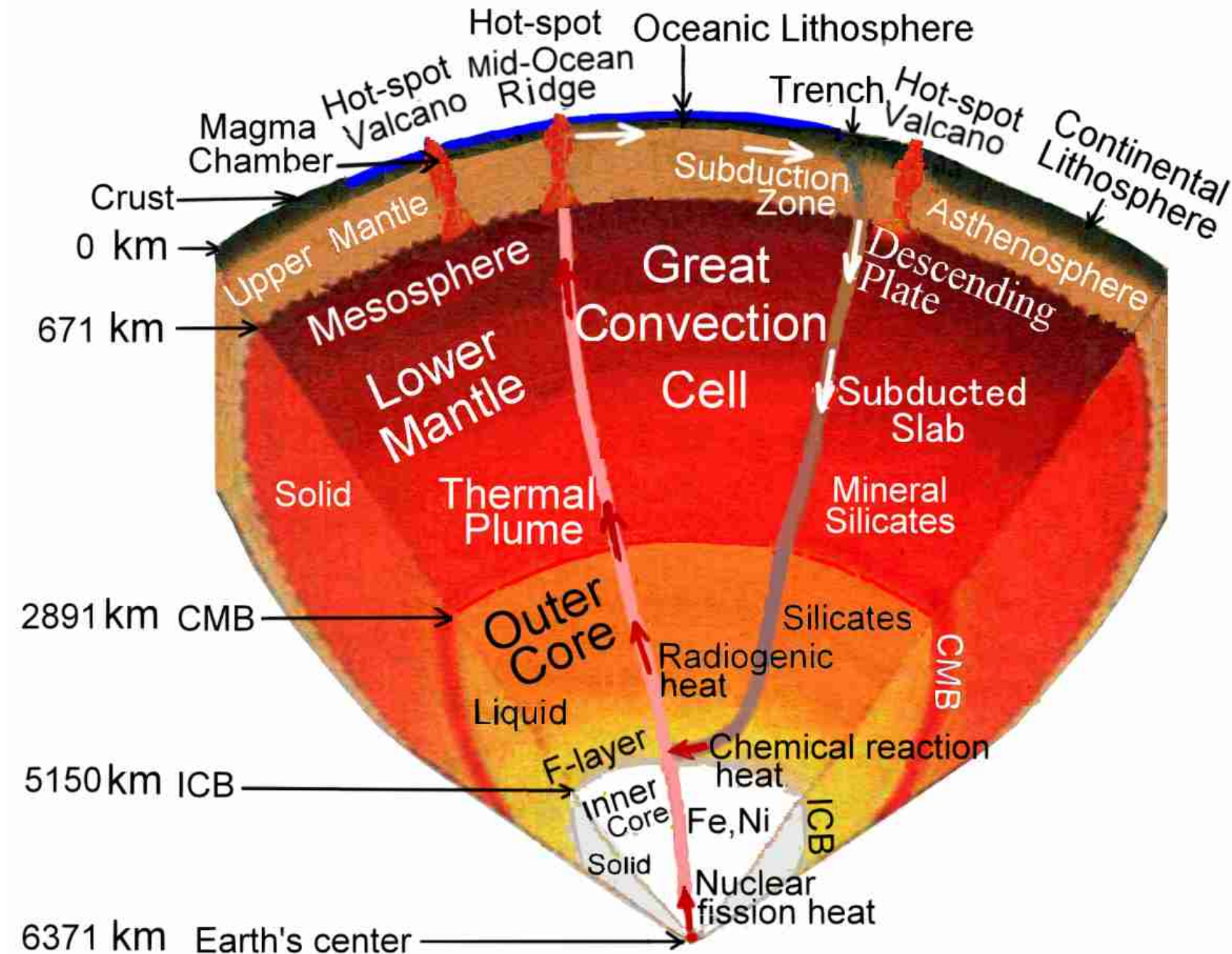

Apply simplified method to calculate the data of Earth

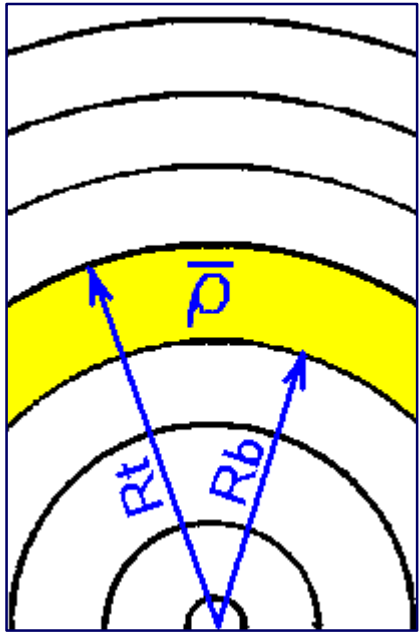

A shell in the Earth's interior

In order to calculate the data of the Earth, the density distribution follows the divisions of the PREM divided into 94 levels, including 82 thin shells. A simplified method is applied to calculate the information of the Earth, as following.

The mass of a uniform sphere M , $M = (4/3)\pi\rho R^3$ (1)

The mass ΔM of each shell in the Earth's interior :

$$\Delta M = (4/3)\pi \bar{\rho} (R_t^3 - R_b^3) \quad (2)$$

The density $\bar{\rho}$ is the mean value of the density at top ρ_t and at the bottom ρ_b of a shell.

The moment of inertia I , $I = (2/5)MR^2$ (3)

The moment of inertia ΔI of each shell :

$$\Delta I = (8/15)\pi \bar{\rho} (R_t^5 - R_b^5) \quad (4)$$

According to the formula of fluid statics and gravitation

$$dP/dR = -g\rho, \quad g = GM/R^2 \quad (5)$$

g is the acceleration due to gravity, and the mass M within the sphere of radius R . G is the gravitational constant $6.6726 \times 10^{-11} \text{ m}^3/\text{kg}\cdot\text{s}^2$.

$$\Delta P = (1/R_b - 1/R_t)G \bar{m} \bar{\rho} \quad (6)$$

ΔP is the difference in pressure between the top and the bottom in a shell of the Earth, and \bar{m} is the mass of a sphere as the mean value of the masses of the sphere within the top radius R_t and the bottom radius R_b respectively of a shell.

$$\Delta P_c = (2/3)\pi G \bar{\rho}^2 R_c^2 \quad (7)$$

ΔP_c is the difference in pressure between the radius R_c and the center of the Earth at the center portion. To check the simplified method can be applicable or not as follows.

The calculated values of the simplified method from the density distribution of the PREM compared with the data of the current earth

Data of the Earth	Mass	Moment of inertia	Pressure at CMB	Pressure at Earth's center	Gravity at CMB	Gravity at Earth's surface
Unit	10^{24} g	10^{40} g.cm ²	kbar	kbar	cm/sec ²	cm/sec ²
PREM & Current	5972.200	80286.400	1357.509	3638.524	1068.230	981.560
Calculated values	5973.289	80205.664	1358.335	3655.973	1068.680	981.959
Difference %	-0.0152	-0.1006	+0.0608	+0.4796	+0.0421	+0.0406

According to the table, the deviations of each value are almost below 0.1%, except pressure at Earth's center that indicate the simplified method is really suitable.

The pressure P of PREM indicates a considerable discrepancy with the simplified method

The curve of deviations E from the crust to the CMB is showed nearly as a straight line, indicating that the calculated pressures have the systematic errors in view of the error theory. But from the CMB to the Earth's center, the slope of curve E sharply increases above the dashed line, which is the straight line extended from the CMB. It indicates that there is a considerable discrepancy within the core, worth to explore.

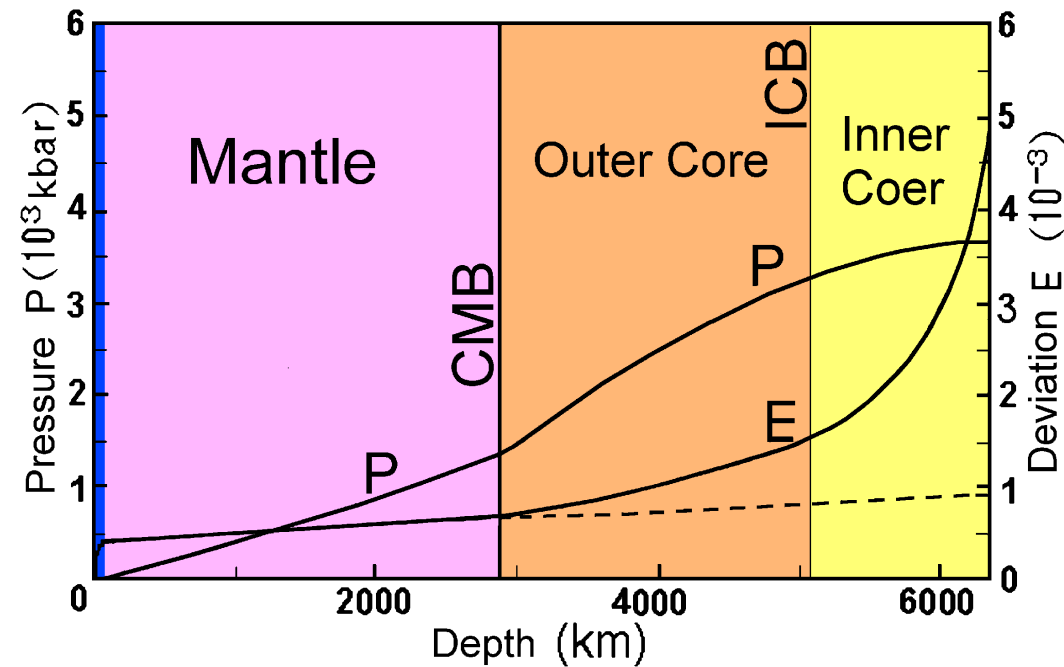

The pressure P of PREM and the deviation E

At ICB is adopted highest density jump

On the basis of the free oscillation periods, Derr (1969) has inferred a jump in density of 2.0 g/cm^3 at ICB that satisfies the known mass and moment of inertia. Bolt and Qamar (1970) first proposed the amplitude ratio ($PKiKP/PcP$) technique and estimated a maximum density jump of 1.8 g/cm^3 at the ICB. Souriau and Souriau (1989) used the amplitude ratio $PKiKP/PcP$ at short distances to be in the range of $1.35 \sim 1.66 \text{ g/cm}^3$. Shearer & Masters (1990) used "non-observations" of $PKiKP$ on the observed amplitude of this phase, leading to upper bounds $\Delta\rho = 1.8 \text{ g/cm}^3$. At the ICB, a density jump of 0.68 g/cm^3 in the PREM is too small to compare with the previous data. We use the highest density jump of Derr's suggestion 2.0 g/cm^3 at the ICB to research the new earth model.

Drawing up the interior constitution of new Earth model

Study on the composition and density of the Earth, the data of PREM model is retained in part of the ground to the CMB for the purpose of calculating mass and moment of inertia of the Earth's crust to mantle. Based on the above referred that the chemical compositions of the mantle and outer core are similar, and density distribution should be continuous, so extending the density distribution of lower mantle straightly into outer core. Drawing up four different density curve in the CMB to ICB. Discontinuity at the ICB and density jumps to appreciate large, so 2.0 g/cm^3 is adopted. In the ICB to the Earth's center, in accordance with the relative part of the PREM model with the same curvature of the curve. The part of core is made up of four different density distribution curve.

The new Earth model compared with the PREM

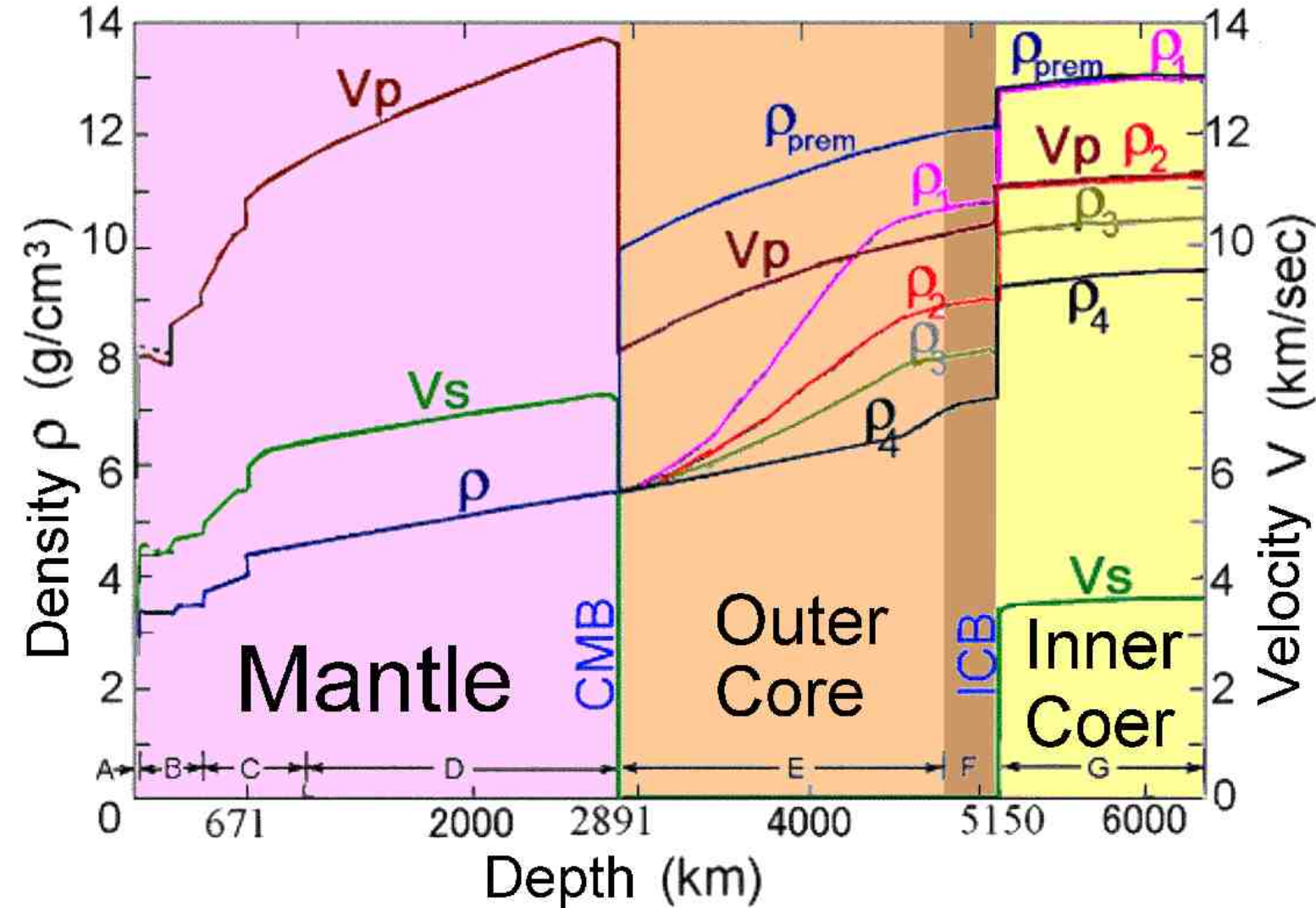

These densities ρ of the new Earth models 1, 2, 3 and 4 compare with the PREM's.

In order to explore the internal structure of the Earth, we developed density distributions of four new modes and the PREM. V_p is for seismic P-wave velocities, V_s for shear wave velocity and ρ for density. The density distribution of four new models are ρ_1 , ρ_2 , ρ_3 and ρ_4 respectively in the core.

The insufficiencies of the mass and the moment of inertia in the four new earth models.

Earth model	Unit	Observed value	New model 1	New model 2	New model 3	New model 4
Mass	10^{24} g	5974.200	5409.024	5268.126	5204.761	5121.820
Insufficiency	10^{24} g		565.176	706.074	769.439	852.380
Moment of inertia	10^{40} g.cm ²	80286.400	77007.472	76571.028	76378.768	76126.841
Insufficiency	10^{40} g.cm ²		3278.928	3715.372	3907.632	4159.559

A dark planet is considered as a sphere to calculate its data through the simplified method

The dark matter is considered as a dark planet, of which the form is similar to Mars and its characteristics are based on the inner planets of the solar system. In order to cut a figure of the dark planet, it is considered as a sphere, whose radius and density can be calculated from the insufficiencies of the mass and the moment of inertia of the Earth through the simplified method. Since the Earth's orbit around the Sun may be affected by the gravity of the dark planet, but no abnormal effect on the Earth has been observed. So an assumption is suggested that the gravity centers of the Earth and the dark planet coincide with each other at the same point. It is inferred from the phenomenon in which the same side of the Moon always faces the Earth that means the Earth and the dark planet may rotate synchronously.

Evaluation of the data in the common part of two planets

The total values of mass and moment of inertia may be obtained from the sum of them. The pressure difference $\Delta P'$ between the top and the bottom of a shell within the Earth.

$$\Delta P' = (1/R_b - 1/R_t) G \bar{M}' \bar{\rho} \quad (8)$$

\bar{M}' is the mean value of the total mass of the Earth and the dark planet within the radius R_t and R_b . The average density $\bar{\rho}'$ of the central portion combined with the Earth and the dark planet within the radius R_c .

$$\bar{\rho}' = (M_c + M_d) / [(4/3)\pi R_c^3] \quad (9)$$

M_c and M_d are the masses of central portion in the Earth and dark planet. $\Delta P_c'$ is the difference of pressure between the top and the center of the central portion in the Earth.

$$\Delta P_c' = (2/3)\pi G \bar{\rho} \bar{\rho}' R_c^2 \quad (10)$$

The calculated data of new four earth models compared with the data of current earth and the PREM

Earth's model Kind of	The Earth planet							The dark planet					Suitability
	Radius	Average density	Mass	Moment of inertia	Center density	Center pressure	Moment of inertia coefficient	Radius	Average density	Mass	Moment of inertia	Moment of inertia coefficient	
Unit	km	g/cm ³	10 ²⁴ g	10 ⁴⁰ g.cm ²	g/cm ³	kbar	C	km	g/cm ³	10 ²⁴ g	10 ⁴⁰ g.cm ²	C	
PREM	6371	5.5150	5974.200	80286.400	13.08848	3638.524	0.3309						
Model 1	6371	4.9935	5409.024	77007.472	13.08848	3283.754	0.3508	3808.414	2.4427	565.176	3278.928	0.4000	no
Model 2	6371	4.8635	5268.126	76571.028	11.29785	3039.584	0.3581	3732.304	3.2421	706.074	3715.372	0.3777	no
Model 3	6371	4.8050	5204.761	76378.768	10.46002	2934.587	0.3615	3717.755	3.5747	769.439	3907.632	0.3674	no
Model 4	6371	4.7284	5121.820	76126.841	9.49821	2805.297	0.3662	3700.375	4.0161	852.380	4159.559	0.3564	good

According to the table, the optimum pattern of model 4 is adopted as the new Earth model.

The data of the new Earth model compared with the data of the current Earth and the PREM

Data of planet	Radius	Mass	Inertia of moment	Average density	Center density	Center pressure	Coef-ficient
Unit	km	10^{24} g	10^{40} g.cm ²	g/cm ³	g/cm ³	kbar	C
PREM and current earth	6371.000	5974.200	80286.400	5.515	13.08848	3638.524	0.3309
Earth planet	6371.000	5121.820	76126.841	4.7284	9.49821	2805.297	0.3662
Dark planet	3700.375	852.380	4159.559	4.0161	7.96097	1115.272	0.3564

Data of the New Earth Model

Earth Planet		Dark Planet	
radius	Mass	Radius	Mass
6371 km	5121.820 $\times 10^{24}$ g	3700.375 km	852.380 $\times 10^{24}$ g
85.73% of global Earth		14.27% of global Earth	

In the new Earth model the mass of the Earth compares with the current observed data about 85.73 %, and the dark planet within the Earth about 14.27 %, which is about 1.33 times of Mars.

The missing mass is a dark planet within the Earth

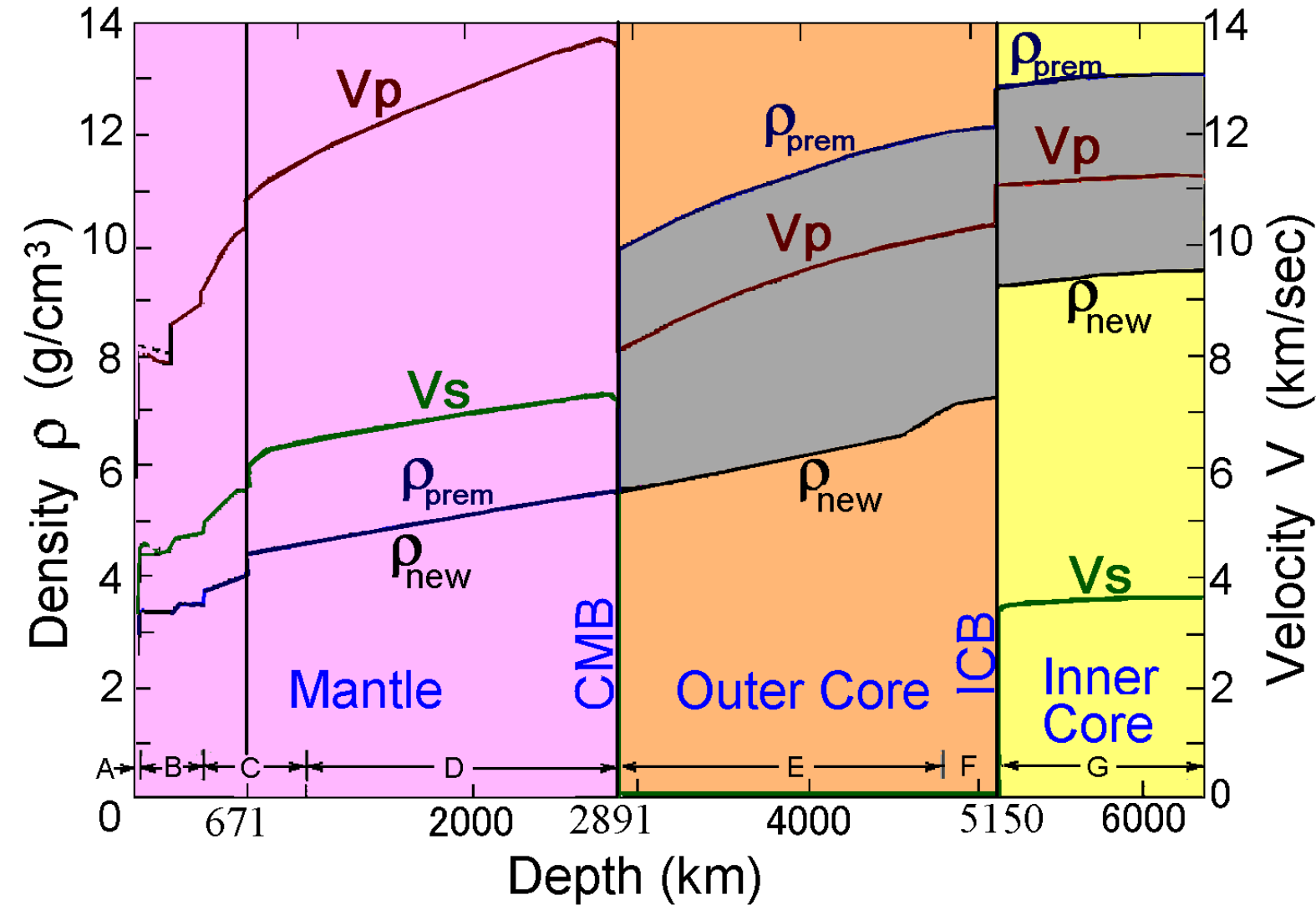

Data of PREM and the new Earth model

ρ curve is density distribution of PREM, and ρ_n is new Earth model. From a different view, the mass in grey color part is missing, because it should be in a different space other than our world. We infer it is the mass of a dark planet within the Earth.

Diagram of the gravity g and the pressure P of the new Earth model and the PREM

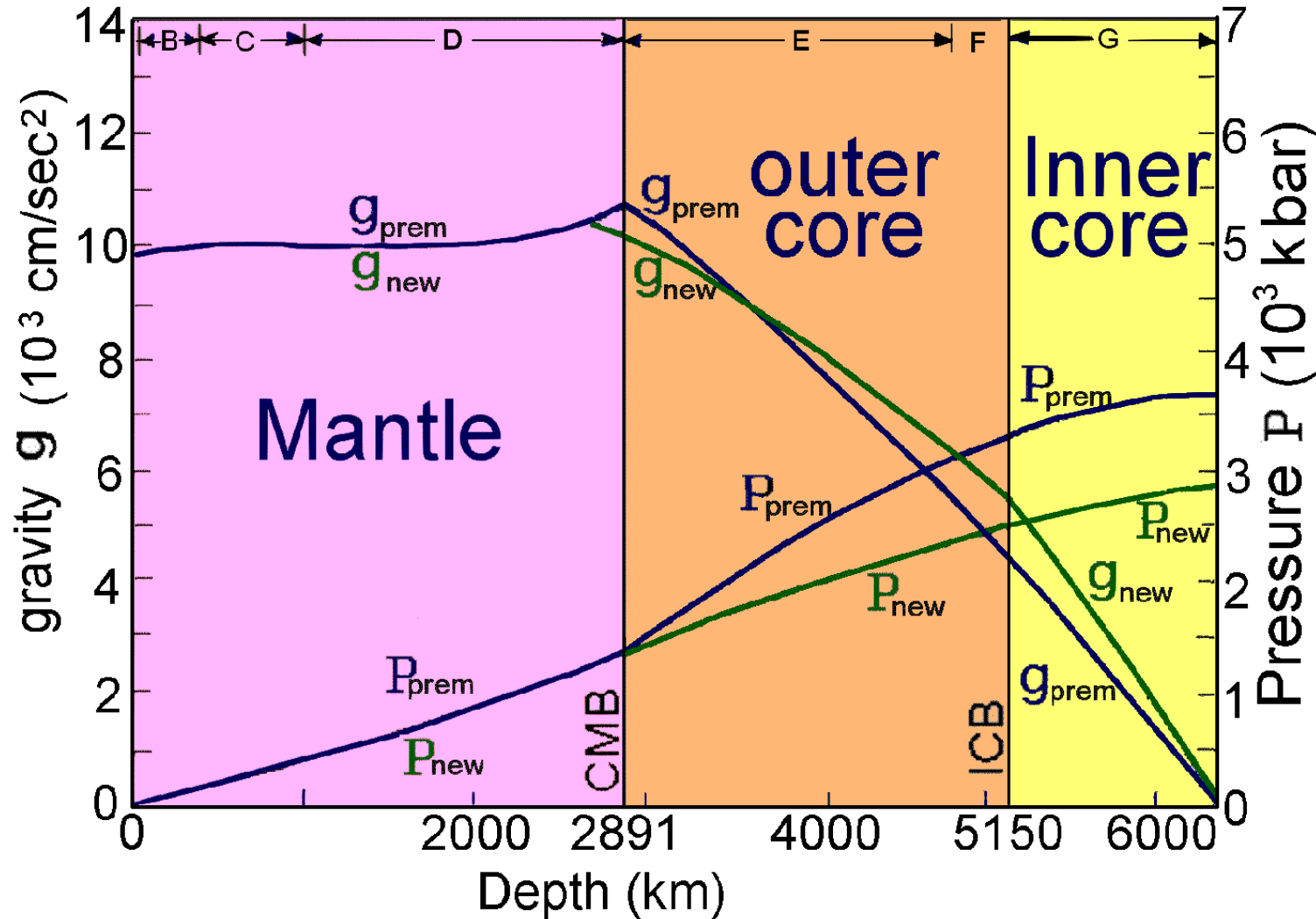

The pressure curve P of the new Earth model is smoother than that of the PREM below CMB. The gravity curve g of the new Earth model, there are two deflection points in the curve that are due to the affection of dark planet.

The data of gravity g and the pressure P

The effect of Chandler wobble may confirm the existence of a dark planet inside the Earth

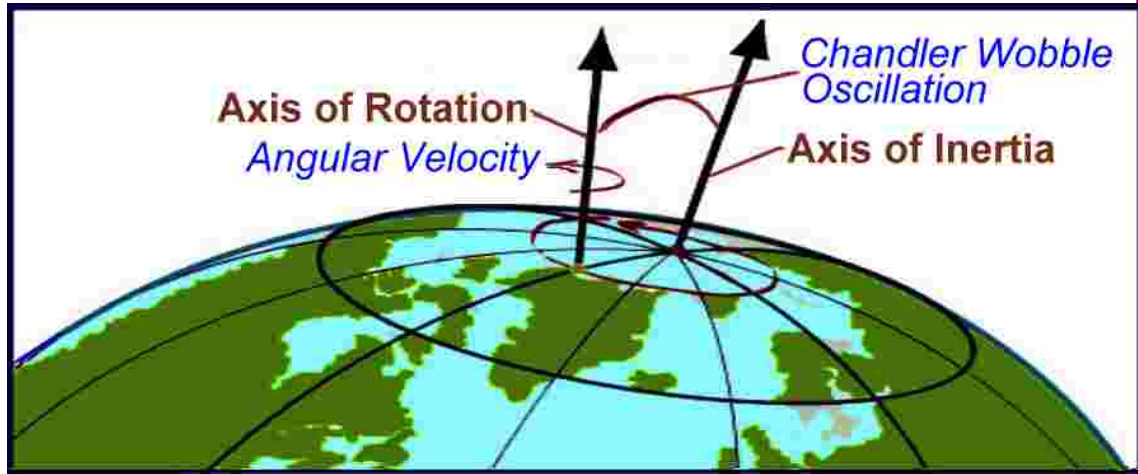

Chandler wobble, period of 14 months, has not been solved the problem for more than one hundred years. The fixed side of the Moon always orbit around

Earth, which is of the Moon's synchronous rotation with the Earth. Since that both the Earth and the dark planet spin synchronously around the same gravity center are postulated, but the rotation axes of both are impossible coinciding with each other; produce the Chandler wobble as the nutation due to the effects of the Moon on non-parallel rotation axes with the Earth's. The effect of Chandler wobble may confirm the existence of a dark planet inside the Earth.

An invisible compact object of Cygnus X-1 may be a dark matter

In 1979, Stokes & Michalsky detected that Cygnus X-1 is a hot super giant star orbited by an invisible compact object in a period of 5.6 days. The mass of the compact object can be estimated from the Doppler shifts in the spectrum of the visible super giant star. The mass of Cygnus X-1 is about 9 times of the sun. This is considerably more than the maximum mass of a neutron star. Therefore, the compact object is not a neutron star or a white dwarf star. Since it has problems of optical confirmation, it is believed that the compact object may not be a black hole. If we consider the compact object of Cygnus X-1 as the dark matter in the other Universe than ours and its gravity affects Cygnus X-1, the problem may be solved.

Dark matter may be in Hyades supercluster

In 1993, Casertano and his coworkers found the stars that evaporate from the Hyades cluster will remain within a few hundred parsecs ($1 \text{ pc} = 3.26 \text{ light year}$) of the cluster only if they are dynamically bound to a much more massive entity containing the cluster. A local mass enhancement of at least $(5-10) \times 10^5$ solar masses, with a radius of about 100 pc, can trap stars with an origin related to that of the Hyades cluster and explains the excess of stars with velocities near the Hyades velocity that constitutes the Hyades supercluster. Part of this mass enhancement can be in visible stars, but a substantial fraction is likely to be in the form of dark matter. This dark matter should be in another Universe than ours.

From Halley's Comet period of old data Brady predicted an invisible planet X



Halley's Comet

Historically the prediction of Halley's Comet has always been errors of 3 or 4 days in the predicted time of the perihelion passage. In 1972 Brady used a computer to treat the data of old European and Chinese records has been able to predict an invisible planet X, which was about three times the size of Saturn with highly inclined orbit to the ecliptic about 120° and a period of 450 years.

A proposed planet X may affect the motion of Neptune and Uranus

In 1981, Flandern proposed a search for a planet X, which has about three times the mass of the Earth and a highly inclined eccentric orbit that accounted for all of the perturbations on the motions of Neptune.

In 1987, from observed astronomical data of the nineteenth century Anderson presented the deviation of Neptune and Uranus in the regular orbit and proposed “The Theory of Planet X”, which described the mass of planet X is about five times that of the Earth and its period is about 700~1000 years. The orbit is elliptical and the inclination from the orbit to ecliptics very large and almost perpendicular.

Pioneer 10 was pulled back to the direction of Sun

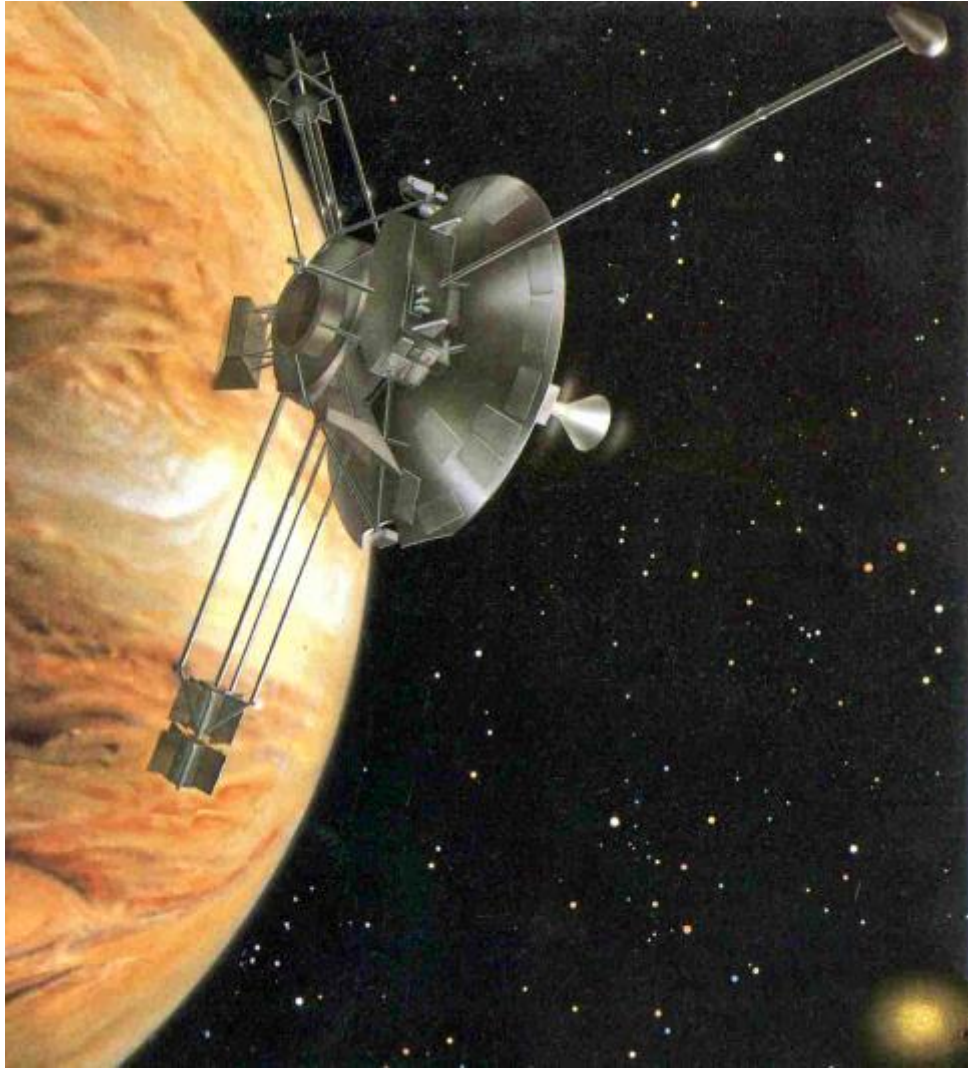

Space probe pioneer 10
arrived near Saturn

In 2002, scientists discover that when space probe pioneer 10 arrived near Saturn, due to unknown forces was pulled back to the biased direction of the Sun, at a time when deeper into space, and that force is not abating. Because of existing theories cannot explain this Universe's mystical power, the probe has revealed a new force of nature. The existing theories of cosmology and space travel will face a significant impact. This phenomenon may be under the influence of planet X.

Dark planet X may solve astronomical problems

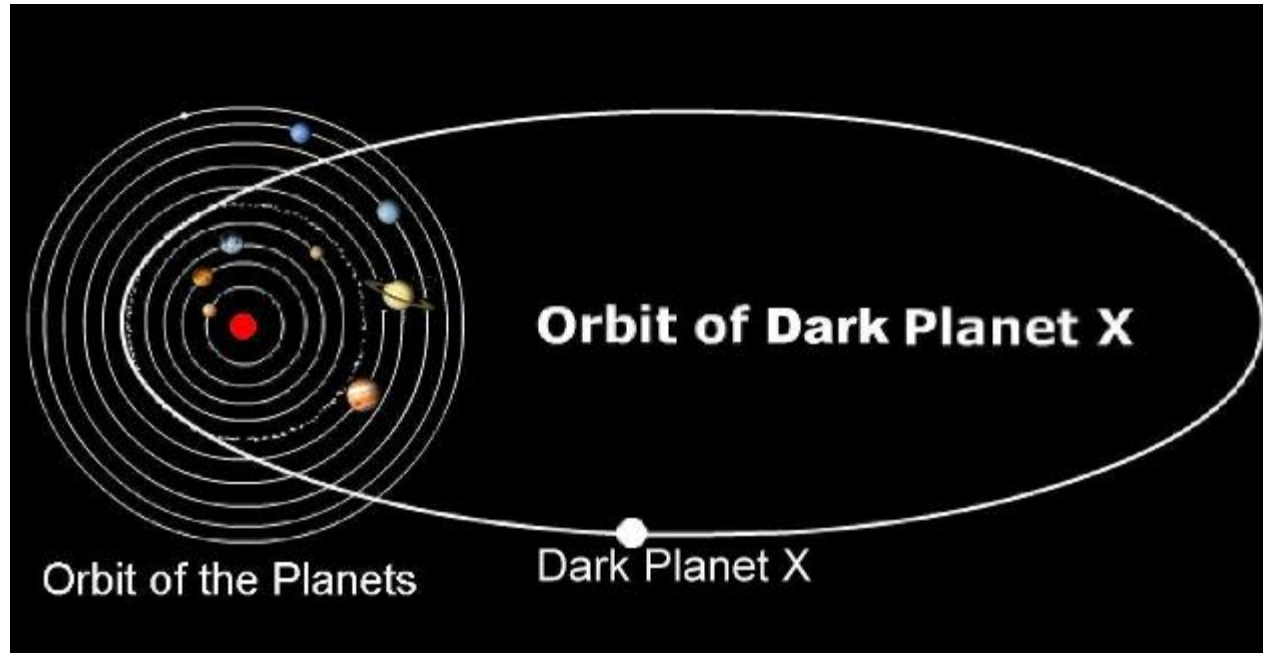

Recent observations by the Hubble space telescope in space, there is no the existence of other planets in the solar system. If the dark planet X orbits around the Sun in the other Universe than ours, then its gravity will sometimes affect the motion of Halley's Comet, Neptune and Uranus. Therefore, the problem of the invisible planet X may be solved, and that can solve problems of astronomical observation.

Study on the Earth's model has asked the Academia Sinica support

箋 用 院 究 研 央 中



In 1990, I wrote to Wu Ta-you, the President of the Academia Sinica, the research proposal: "Apply geoscience to explore dark matter in order to confirm Superstring theory", and ask a favor of support. This is President Wu replied letter, but no subsequent answer.

In 1993 the paper was presented and assessed as "best paper award"

何甄荣先生:

您的論文《地球新模式的重建和內部
黑暗物質的發現》在首屆海峽兩岸 UFO
學術研討會上被評為優秀論文,特發證書,
以資鼓勵。

中國 UFO 研究會
理事長

1993.12.7. 北京.

On December 7, 1993, "the first cross-straits Symposium on UFO" was held in Beijing, China, my paper of "*Reconstruction of the Earth Model and Discovery of the Interior Dark Matter*" was presented, and is assessed as "best paper award".

Document of best paper award